



A Novel Detection Method Based on Enhanced Diagonal Secant Updating Frequency Domain Fourth-Order Cumulant Scheme for DSSS Signals

Saleh Ghorbani¹, Saeed Ghazi-Maghrebi^{1*}

¹ Department of Communications, Faculty of Electrical Engineering, Yadegar-e- Imam Khomeini (RAH) Shahre Rey Branch, Islamic Azad University, Tehran, Iran.

Received: 07-Mar-2020, Revised: 04-Jul-2020, Accepted: 08-Jul-2020.

Abstract

In this paper, an asymptotic estimating technique to detect direct sequence spread spectrum (DSSS) signals using modified frequency domain fourth-order cumulant is proposed. Based on 2-D slices fourth-order cumulant, an efficient algorithm is proposed to solve the problem of complex computation and huge processing time. The method of fourth-order cumulant in frequency domain can achieve detection probability above 50% at SNR -25dB. In this paper, we strongly decrease processing time and complexity of computations that it makes this method appropriate for employing in the DSSS detection systems. This method only requires to store a row vector while ignoring all the low and diagonal elements and therefore the required memory is highly reduced. In addition, as it uses two-line search strategies (predictor and corrector) to obtain a new iterative point, the spectral properties of the diagonal updating scheme is improved, and rapid convergence property is gained. Also, this method estimates carrier frequency and symbol rate simultaneously in the online processing. Simulation results and computation analysis indicate that processing time of the proposed method is decreased about 30% with respect to the commonly used fourth-order cumulant methods.

Keywords: DSSS signal, Frequency domain fourth-order cumulant method.

1. INTRODUCTION

Direct sequence spread spectrum (DSSS) technology has been widely used in military

and non-military communication systems [1]. The initial progress in DSSS detection systems is referred to more than twenty-five years ago. Therefore, both the research and

*Corresponding Authors Email:
s_ghazi2002@yahoo.com

military products for DSSS are almost new. It must be noted that the usage of the high order statistics in this domain is newer and a number of military research institutes and industries are currently involved. Basically, in spread spectrum technology, signals have a bandwidth significantly larger than the baseband signals [1-3]. The DSSS signals have very low power spectral density (PSD) and thus they are transmitted with negative SNR (below the noise level) [1-5]. Furthermore, they have anti-jamming and lower probability of interception properties [1].

Since the use of the low probability of intercept communication technology is very important subject, mainly, the DSSS signal detection has been a hot title for researchers.

In the non-military domain, many transmitters have been able to share the same frequency bandwidth with low inter symbol interference (ISI) [1], [2]. In the DSSS transmission, the information signal is multiplied by a periodic pseudo-random sequence. Results of this multiplication in the frequency domain is a wideband signal with lower level of maximum peak and as a result it decreases the probability of interception [1]. For spectrum surveillance, the pseudo-random sequence in the transmitter is unknown. It must be noted that the lack of other transmitter parameters such as sequence duration, symbol period, channel estimation, modulation type, data encryption and carrier frequency make DSSS detection and interception very difficult [1]. Nowadays, higher-order statistic models are developed for DSSS signals detection. On the other hand, the general higher-order statistics may not be easily applied to signal processing

because of the existence of two problems including too complex computation and too long time of processing.

In this paper, we first provide both a comprehensive comparison of the DSSS detection and parameter estimation systems for military applications. Also, we propose a new method to process time reduction for estimation of symbol period and carrier frequency of DSSS signals without any information about the transmitter parameters. For the proposed method, we applied enhanced diagonal secant updating frequency domain 2-D slices fourth-order cumulant technique. This technique is a modified version of Newton-like methods with a very good solving speed and the best performance among the Newton-like methods [6].

The paper is organized as follows. In Section 2, the mathematical performance analysis of different methods is introduced. In Section 3, the commonly used classical fourth-order estimator is formulated. Section 4 is the application and illustration of the enhanced diagonal secant updating scheme based on the fourth-order cumulant. Finally, numerical results and conclusions are presented in the Section 5.

2. MATHEMATICAL PERFORMANCE ANALYSIS OF DIFFERENT METHODS

In a DSSS signal with short code, a pseudo-random code is multiplied to each symbol. The received baseband signal, with the information symbol of $d_j \in \{1, -1\}$ and code chips of $c_k \in \{1, -1\}$ will be [2]

$$\begin{aligned}
 y(t) &= d(t)c(t) + n(t) \\
 &= \sum_{j=-\infty}^{\infty} d_j \sum_{k=0}^{N-1} c_k g(t - lT_s - kT_c) + n(t)
 \end{aligned} \tag{1}$$

which T_c and T_s are the code width and the symbol width respectively. Also, N is the length of pseudo random code ($T_s = NT_c$), $g(t)$ is the code waveform and $n(t)$ is the receiver input noise. If the carrier frequency is not estimated completely, the resulting signal will be

$$y(t) = \sum_{l=-\infty}^{\infty} d_j \sum_{k=0}^{N-1} c_k g(t - lT_s - kT_c) \exp(j\omega_c(t + lT_s + kT_c)) + n(t) \quad (2)$$

In this paper, we assumed that the symbols code chips are uncorrelated with zero mean. The received noise $n(t)$ is AWGN with zero mean and two-sided power spectral density of $N_0/2$, which is uncorrelated with the DSSS received signal. It must be noted that the signal to noise ratio (in dB) before spreading is negative.

2.1. Radiometer Detector

The most appropriate approaches to detect signal interception must be based on radiometry, which are measurement of received energy in selected time and frequency intervals. However, such radiometric methods, as shown in Figure 1, can be highly susceptible to unknown and changing noise levels and interference activity. In this figure, the input matched filter is matched with the complex conjugate of the received signal [3-5]. This filter maximizes the SNR at the detector output. In this method, decision statistics are produced by summing the square of I and Q components. With the number of I and Q as N_c and $2N_c \gg 1$, central limit theorem shows that the statistic distribution function can be estimated as a Gaussian distribution. For

active signal in the receiver input, the output distribution of the integrator is normal distribution $N(m_n, \sigma_n)$, with average of m_n and standard deviation of σ_n .

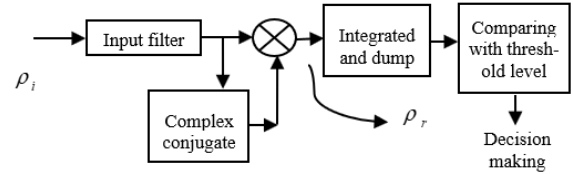

Fig. 1. Radiometer detector.

It is assumed that signal in the receiver input has a normal distribution with average m_s and standard deviation σ_s [4]. To detect the DSSS signal, using assumption testing, it is usually modeled as

$$\begin{aligned} H_0: y(t) = n(t) &\rightarrow P_0(x) = N(m_n, s_n) \\ H_1: y(t) = s(t) + n(t) &\rightarrow P_1(x) = N(m_s, s_s) \end{aligned} \quad (3)$$

Considering the Neyman–Pearson scale and selecting the proper threshold level β , using the following equation, the probability of false alarm and detection will be

$$\begin{cases} P_{fa} = \int_{\beta}^{\infty} p_0(x) dx \\ p_d = \int_{\beta}^{\infty} p_1(x) dx \end{cases} \quad (4)$$

In this case, the threshold level of β will be

$$P_{fa} = \frac{1}{\sqrt{2\pi\sigma_n^2}} \int_{\beta}^{\infty} e^{-\frac{(x-m_n)^2}{2\sigma_n^2}} dx \quad (5)$$

$$\beta = \sigma_n \sqrt{2} \operatorname{erfc}^{-1}(sP_{fa}) + m_n \quad (6)$$

where $\operatorname{erfc}^{-1}(\cdot)$ is the complimentary error function and s is a variable for shift β . Utilizing Eq. (6) and defining the output SNR as $p_r = (m_s - m_n)^2 / \sigma_n^2$, the probability of detection will be

$$P_d = \frac{1}{2} \operatorname{erfc} \left(\frac{\sigma_n}{\sigma_s} \left[\operatorname{erfc}^{-1}(2P_{fa}) - \sqrt{\frac{\rho_r}{2}} \right] \right) \quad (7)$$

Because the input SNR is low, in the complex multiplier output, the signal \times signal and signal \times noise can be ignored and also $\sigma_s = \sigma_n$. In this case, the probability of detection, based on the output SNR, is simplified as bellow

$$P_d = \frac{1}{2} \operatorname{erfc} \left(\operatorname{erfc}^{-1}(2P_{fa}) - \sqrt{\frac{\rho_r}{2}} \right) \quad (8)$$

In this method, the DSSS signal periodic structure is not used and detection is carried out only by signal energy. Hence, it is not possible to distinguish normal signals with positive SNR from the DSSS signal. Therefore, this method is not suitable for practical implementation and it is used only for theoretical comparisons [4].

2.2. Frequency Doubler Detector

The frequency doubler and chip rate detectors categorized extract features from the input signal [11]. Both chip-rate and carrier detectors have better performance than the radiometer in terms of discriminating against interfering signal power or varying noise levels. Figures 2 and 3 show a feature-based detector and a frequency-doubler detector respectively.

Equation (9) shows that in the frequency doubler detectors with zero delay, the signal of the mixer output is equal to $y^2(t)$ [7-8]. As a result, the detector output frequency is twice of the carrier frequency. Consequently, the input signal carrier frequency can be estimated:

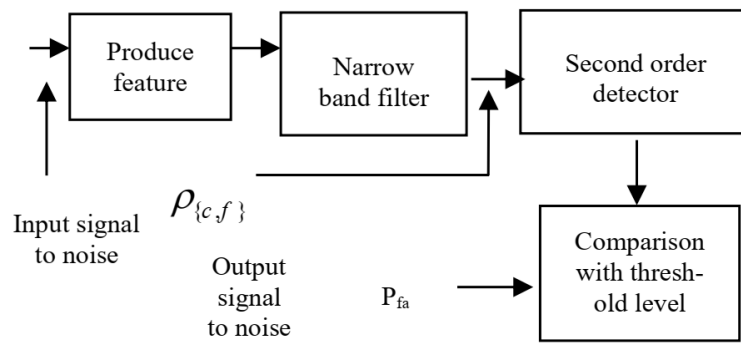

Fig. 2. Diagram of feature-based DSSS signal detector.

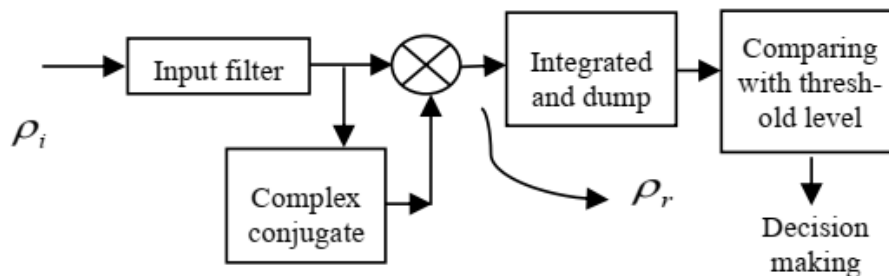

Fig. 3. Diagram of frequency-doubler DSSS signal detector.

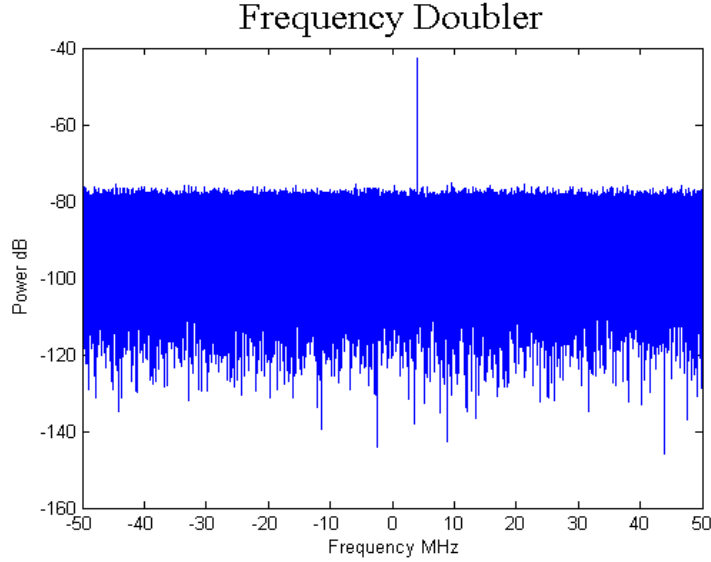

Fig. 4. Estimation of detector output spectrum in frequency doubler.

$$\begin{aligned}
 y^2(t) &= \left(\sum_{i=-\infty}^{\infty} d_j \sum_{k=0}^{N-1} c_k g(t - lT_s - kT_c) e^{j\omega_c(t+lT_s+kT_c)} + n(t) \right) \\
 &= e^{2j\omega_c(t+lT_s+kT_c)} + n^2(t) \quad (9) \\
 &+ 2n(t) \sum_{l=-\infty}^{\infty} d_j \sum_{k=0}^{N-1} c_k g(t - lT_s - kT_c) e^{j\omega_c(t+lT_s+kT_c)}
 \end{aligned}$$

Figure 4 shows the estimation of the detector output spectrum in a frequency doubler for a DSSS signal with a chip rate of 4 MHz. The number of chips per symbol is 31 (symbol rate is 129/03 kHz), SNR= -10 dB, the carrier frequency is 4 MHz and sampling frequency is 100 MHz. It is obvious that the frequency power at frequency of 8 MHz is detectable with a suitable threshold.

The SNR of the frequency tone, based on the processing gain at the receiver, will increase [9], [10]. The processing gain is a

function of the received signal chip rate and filter bandwidth, which is a narrowband filter for detection of the frequency tone. Since FFT transform is used for a narrowband filter, the processing gain depends on the processing signal time.

Equation (9) shows the multiplier output which includes sinusoidal tone and noise. If the sinusoidal tone is detected by a frequency doubler detector and signal \times signal and signal \times noise are ignored, for long-time integration ($N_c \gg 1$), the probability density function of the Q and I channels will be Gaussian distribution with zero mean. The Decision statistics is calculated from the summation of the square of these independent channels (Q and I), that they, will be Rician distribution.

$$P_d = \int_{\beta}^{\infty} e^{-(x+\rho\{c,f\})} I_0(2\sqrt{xr\{c,f\}}) dx \quad (10)$$

where $I_0(0)$ is the corrected zero-order Bessel function, ρ_c and ρ_f are the output SNRs of the chip rate and frequency doubler

detectors respectively. With no active signal in the receiver input, $\rho\{c, f\}$ will be zero. Inserting P_d with P_{fa} in Eq. (10) makes the probability of false alarm as bellow

$$P_{fa} = \int_{\frac{\beta}{2\sigma^2}}^{\infty} e^{-x} dx = e^{\frac{-\beta}{2\sigma^2}} \quad (11)$$

Considering the threshold as $\beta = -2\sigma^2 \ln(p_{fa})$, the probability of detection will be

$$P_d = \int_{-\ln(p_{fa})}^{\infty} e^{-(x+r\{c, f\})} I_0\left(2\sqrt{xr\{c, f\}}\right) dx \quad (12)$$

2.3. Chip Rate Detector or Delay and Multiply

To detect the signal, we multiply the DSSS signal with its delayed version. It is based on the periodic feature of the DSSS signal and therefore symbol rate and chip rate can be estimated concurrently [11-18]. A conventional chip-rate detector comprises a delay-and-multiply circuit such as an auto-correlation. It multiplies the received composite DSSS signal by the conjugate of the composite received DSSS signal delayed by a time T_d . The performance of this method is evaluated for signal detecting with low SNRs. At constant sampling frequencies and increasing the processing signal lengths, it is possible to estimate the DSSS signal

parameters at low SNRs. Using Eq. (1), and delayed signal with T_c , multiplying the delay signal with the input signal, it yields

$$u_s(t) = d(t)d(t-T_c)c(t)c(t-T_c) \quad (13)$$

Since $T_c \ll T_s$, we conclude that $d(t-T_c) = d(t)$ (except in the first chip). Hence, in the detector output, there are multiple of pseudo-random codes and delayed form of them alternatively. With assumption of $c = [c_0, c_1, \dots, c_k, \dots, c_{N-1}]$ as pseudo-random code chips, the detector output will be

$$u_s(t) = \left[(d_{j-1}c_{N-1})(d_j c_0) \right. \\ \left. \cdot (c_0 c_1, c_1 c_2, \dots, c_k, \dots, c_{N-2} c_{N-1}) \right] \quad (14)$$

In practice, before detection, there is no information about T_c and t_d (propagation delay on the DSSS received signal). If $t_d < T_s = NT_c$, the output signal will be periodic, however, the optimized delay will be T_c (15). By calculating the auto correlation function of the resulting signal, we can detect the DSSS signal with a negative SNR and estimate the signal symbol rate. Also, with delay equal to T_c , we can obtain the best result for symbol rate estimation (15). In order to estimate the chip rate, we can use the estimation of the delay-and-multiply output spectrum or the autocorrelation function spectrum.

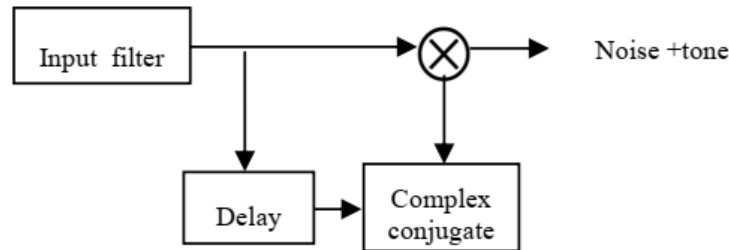

Fig. 5. Chip rate detector.

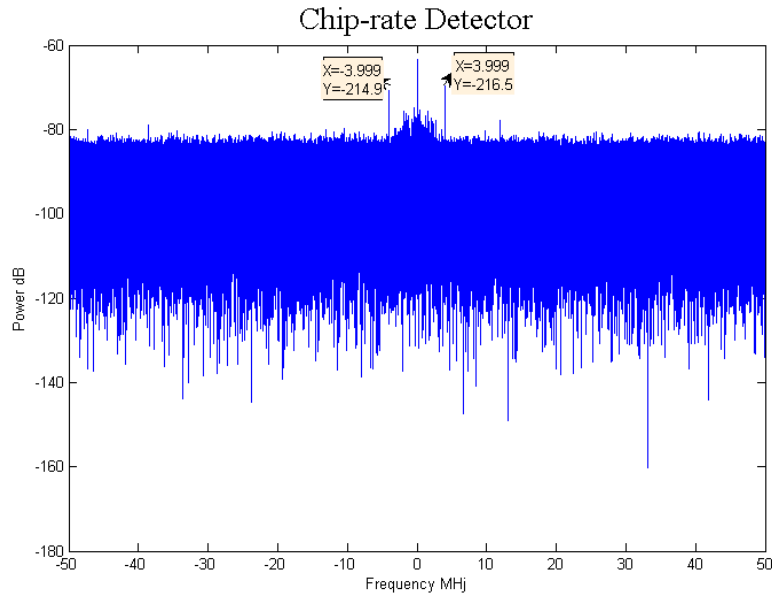

Fig. 6. Estimation of delay-and-multiply output spectrum-

Figure 6 shows direct estimation of delay-and-multiply output spectrum. In this figure, the chip rate-estimation is 4 MHz and hence, it is possible to estimate the DSSS signal bandwidth.

2.4. Oscillation Correlation Estimator

This method is based on the correlation function estimators (19). The originality of the proposed approach is based on the fluctuations of autocorrelation estimators, instead of the autocorrelation itself. In addition to detection of the DSSS signals, it is able to estimate the signal symbol rate [20-23]. Although the DSSS signal autocorrelation function is similar to noise, the variation of the autocorrelation function estimators is completely different, so it is possible to detect a signal from noise [21]. In this method, the received signal is divided by M windows with length of T . For the n th window, the autocorrelation function is

$$R_{yy}^n(\tau) = \frac{1}{T} \int_0^T y(t)y^*(t-\tau)dt \quad (15)$$

and the second order moment is

$$\rho(\tau) = E \left\{ |R_{yy}(\tau)|^2 \right\} = \frac{1}{M} \sum_{n=0}^{M-1} |R_{yy}(\tau)|^2 \quad (16)$$

where $\rho(\tau)$ is the scale of change in $R_{yy}^n(\tau)$. The authors in [1] have shown that if the filter response is shaped uniformly with a rectangular in the range of $[-W/2, +W/2]$, the average and variance of $\rho(\tau)$ in the presence of noise will be

$$\begin{cases} m_{\rho}^{noise} = \frac{1}{TW} \sigma_{noise}^4 \\ \sigma_{\rho}^{noise} = \sqrt{\frac{2}{M}} m_{\rho}^{noise} \end{cases} \quad (17)$$

The function of $\rho(\tau)$, in the presence of a signal, will produce large values for delay amount which is multiple of the symbol period. The average of these big values is calculated as bellow:

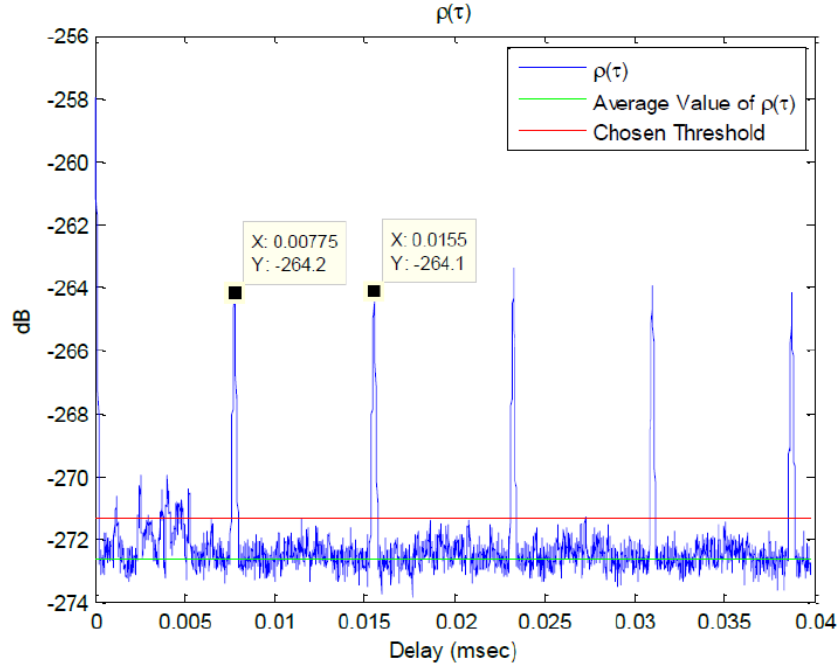

Fig. 7. Function $\rho(\tau)$, noise average and selected threshold levels.

$$m_{\rho}^{signal} = E\{|R_{ss}(T_c)|^2\} = \frac{T_s}{T} \sigma_s^4 \quad (18)$$

where T_s is the symbol period and σ_s^2 is the signal power. The detector output SNR is calculated as bellow

$$\begin{aligned} SNR_{out} &= 20 \log_{10} \left(\frac{m_{\rho}^{(signal)}}{\sigma_{\rho}^{noise}} \right) \\ &= 20 \log_{10} \left(WT_s \left(\frac{\sigma_{signal}^2}{\sigma_{noise}^2} \right) \right) \end{aligned} \quad (19)$$

In order to distinguish large values of $\rho(\tau)$ from the noise, it is necessary to use a proper threshold of $m_{\rho}^{noise} + 4\sigma_{\rho}^{noise}$ [23]. To determine this threshold, we need to estimate m_{ρ}^{noise} . Since it is assumed that there is a negative input SNR at the receiver input, it is possible to use the received signal variance instead of σ_{ρ}^{noise} in Eq. (19), because the signal power is very lower than the noise power.

Figure 7 shows the function of $\rho(\tau)$ with selected noise average and thresholds. In this simulation, the input signal has a 4 MHz chip rate, 129/3 kHz symbol rate, (31 chip codes multiplied in each symbol) and SNR=-10 dB. Detecting the variation of the correlation estimator peaks and calculating time difference between consecutive peaks result in obtaining the symbol rate. This simulation uses 255 windows with an input signal symbol length of 10. This method is resistant to the offset frequency. If the central frequency estimation is imperfect or estimation and omission of the carrier frequency is not carried out, the performance will not be affected [22].

2.5 2D Cutting of the Fourth-Order Cumulant

In this detection method, without the input signal information, we estimate the carrier

frequency and symbol period concurrently [24-27]. Compared with the autocorrelation detector, this method is a key characteristic of the method based on the higher-order cumulants. Moreover, according to the higher-order cumulants, the carrier frequency and the symbol period of DS-SS signal can be estimated simultaneously. In the case of signal without noise, $s(t) = c(t)\cos(2\pi f_0 t)$ with $c(t) = d(t)d_s(t)$, the $d(t)$ is the baseband data with period of T_s and $d_s(t)$ is the pseudo-random code with period of T_c . The second-order until fourth-order cumulants of the received signal are [24], [25]

$$\begin{aligned} C_{2s}(\tau) &= E[s(t)s(t+\tau)] \\ &= \frac{1}{2}R_c(\tau)\cos(2\pi f_0\tau) \end{aligned} \quad (20)$$

$$\begin{aligned} C_{3s}(\tau_1, \tau_2) &= E[s(t)s(t+\tau_1)s(t+\tau_2)] \\ &= 0 \end{aligned} \quad (21)$$

$$\begin{aligned} C_{4s}(\tau_1, \tau_2) &= E[s(t)s(t+\tau_1)s(t+\tau_2)s(t \\ &\quad + \tau_3)] \\ &\quad - C_{2s}(\tau_1)C_{2s}(\tau_3 - \tau_2) \\ &\quad - C_{2s}(\tau_2)C_{2s}(\tau_3 - \tau_1) \\ &\quad - C_{2s}(\tau_3)C_{2s}(\tau_2 - \tau_1) \\ &= \frac{1}{8}E[c(t)c(t+\tau_1)c(t+\tau_2)c(t+ \\ &\quad \tau_3)][\cos 2\pi f_0(\tau_2 + \tau_3 - \tau_1) \\ &\quad + \cos 2\pi f_0(\tau_1 + \tau_2 - \tau_3) \\ &\quad + \cos 2\pi f_0(\tau_1 + \tau_3 - \tau_2) \\ &\quad - \frac{1}{4}R_c(\tau_1)\cos(2\pi f_0\tau_1)R_c(\tau_2 - \\ &\quad \tau_3)\cos(2\pi f_0(\tau_2 - \tau_3)) \\ &\quad - \frac{1}{4}R_c(\tau_2)\cos(2\pi f_0\tau_2)R_c(\tau_3 \\ &\quad - \tau_1)\cos(2\pi f_0(\tau_3 - \tau_1)) \\ &\quad - \frac{1}{4}R_c(\tau_3)\cos(2\pi f_0\tau_3)R_c(\tau_1 \\ &\quad - \tau_2)\cos(2\pi f_0(\tau_1 - \tau_2)) \end{aligned} \quad (22)$$

In the presence of signal and noise i.e. $y(t) = s(t) + n(t)$, Eq. (20), (21) and (22) will be

$$\begin{aligned} C_{2y}(\tau) &= E[s(t) + n(t)][s(t+\tau)n(t+\tau)] \\ &= C_{2s}(\tau) + C_{2n}(\tau) \\ &= \frac{1}{2}R_c(\tau)\cos(2\pi f_0\tau) + \sigma^2\delta(\tau) \end{aligned} \quad (23)$$

$$C_{3y}(\tau_1, \tau_2) = 0 \quad (24)$$

$$\begin{aligned} C_{4y}(\tau_1, \tau_2, \tau_3) &= E\{[s(t) \\ &\quad + n(t)][s(t+\tau_1)n(t+\tau_1)] \\ &\quad [s(t+\tau_2)n(t+\tau_2)][s(t+\tau_3)n(t+\tau_3)]\} \\ &\quad - C_{2y}(\tau_1)C_{2y}(\tau_3 - \tau_2) \\ &\quad - C_{2y}(\tau_2)C_{2y}(\tau_3 - \tau_1) \\ &\quad - C_{2y}(\tau_3)C_{2y}(\tau_2 - \tau_1) \\ &= C_{4s}(\tau_1, \tau_2, \tau_3) + C_{4n}(\tau_1, \tau_2, \tau_3) \\ &= C_{4s}(\tau_1, \tau_2, \tau_3) \end{aligned} \quad (25)$$

Equations (22) and (25) show that the fourth-order cumulant of the received signal is independent of noise and as a result we can detect DSSS signal clearly [24], [25]. Computing $C_{4y}(\tau_1, \tau_2, \tau_3)$ is difficult for the total delay time, so 2D cutting of this function is done using $\tau_1=0, \tau_2=\tau_3=\tau$. As a result, the fourth-order cumulant becomes

$$\begin{aligned} C_{4y}(0, \tau, \tau) &= \frac{1}{8}\cos(4\pi f_0\tau) \\ &\quad - \frac{1}{4}R_c^2\tau\cos(4\pi f_0\tau) \end{aligned} \quad (26)$$

The fourth-order cumulant has a tone at frequency of $2f_0$, and thus we can estimate the central frequency. The second part of Eq. (26) includes input signal autocorrelation and as a result we can estimate the symbol rate. If we suppose the delay numbers are equal to $\tau_1=0, \tau_2=\tau_3=\tau$, the fourth-order cumulant equations are summarized in Fig. 8.

Figure 9 shows the spectrum estimation in this detector. In this simulation, the input signal has a 4 MHz chip rate, 129/3 kHz

symbol rate, (31 chip codes multiplied by each symbol), SNR=-10 dB and central frequency equals to 10 MHz.

In the fourth-order cumulant spectrum, the central frequency is detectable at twice of the input signal carrier frequency. Also, the symbol rate will be estimated through the frequency difference of two subsequent peaks of frequency spectrum [26], [27].

3. CLASSICAL FOURTH-ORDER ESTIMATOR

In this paper, a novel detection based on enhanced diagonal secant updating frequency domain fourth-order cumulant scheme is proposed. Frequency domain fourth-order cumulants are suitable for stationary random process. For a zero mean stationary stochastic signal $x(k)$, the fourth-order cumulant is

$$C_{4x}(\tau_1, \tau_2, \tau_3) = \text{Cum}[x(k), x(k+\tau_1), x(k+\tau_2), x(k+\tau_3)] \quad (27)$$

$$\begin{aligned} \text{Cum}(x_1, x_2, x_3, x_4) &= E\{x_1 x_2 x_3 x_4\} \\ &- E\{x_1 x_2\} E\{x_3 x_4\} - E\{x_1 x_3\} E\{x_2 x_4\} \\ &- E\{x_1 x_4\} E\{x_2 x_3\} \end{aligned} \quad (28)$$

where E is expectation value [3]. With different time delay in Eq. (27) and (28),

online detection is impossible. For a non-stationary or cyclostationary stochastic process, fourth-order cumulants must be modified. With $x(k)$ as a zero-mean random signal, the second-, third- and fourth-order cumulants of $x(k)$ can be derived respectively as bellow:

$$C_{2x}(\tau) = E\{x(k)x(k+\tau)\} \quad (29)$$

$$= \frac{1}{N} \sum_{k=1}^{N-1} x(k)x(k+\tau)$$

$$C_{3x}(\tau_1, \tau_2) = E\{x(k)x(k+\tau_1)x(k+\tau_2)\} \quad (30)$$

$$= \frac{1}{N} \sum_{k=1}^N x(k)x(k+\tau_1)x(k+\tau_2)$$

$$\begin{aligned} C_{4x}(\tau_1, \tau_2, \tau_3) &= E\{x(k)x(k+\tau_1) \\ &\quad x(k+\tau_2)x(k+\tau_3)\} \\ &- C_{2x}(\tau_1)C_{2x}(\tau_2-\tau_3) \\ &- C_{2x}(\tau_2)C_{2x}(\tau_3-\tau_1) \\ &- C_{2x}(\tau_3)C_{2x}(\tau_1-\tau_2) \end{aligned} \quad (31)$$

Being very complicated, the computation of Eq. (31) is not applicable for direct estimation of the moment. Considering the technical realization, we only study four kinds of fourth-order $m_{4x}(0,0,0)$, $m_{4x}(0,\tau,\tau)$, $m_{4x}(\tau,\tau,\tau)$ and $m_{4x}(0,0,\tau)$ with $\tau \neq 0$ [25]. Moreover, the second-order moment of the Gaussian white noise is

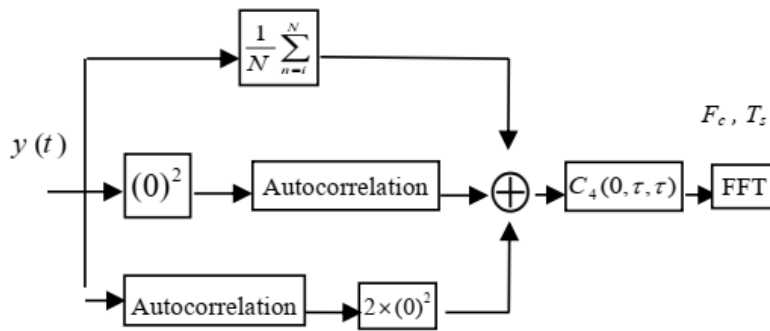

Fig. 8. 2D cutting of the fourth degree cumulant.

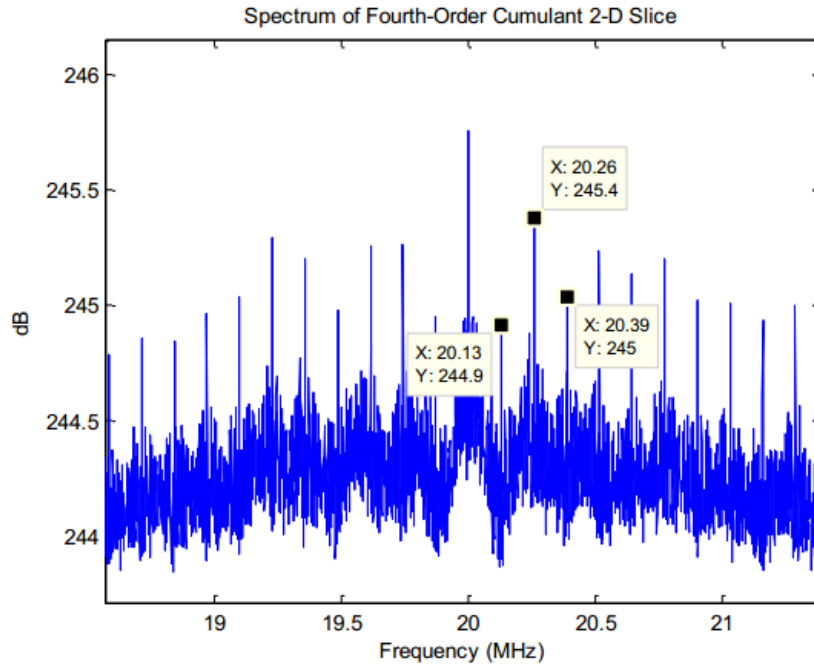

Fig. 9. Spectrum estimation in the 2D cutting of the fourth order cumulant DSSS signal detector.

$$m_{2n}(\tau) = \sigma_n^2 \delta(\tau) \quad (32)$$

According to Eq. (29), (30) and (31), these four kinds of fourth-order moments of the received DSSS signal are as bellow:

$$m_{4x}(0,0,0) = \frac{3}{4} P^2 R_c(0,0,0) + 6\sigma_n^2 P R_c(0) + 3\sigma_n^4 \quad (33)$$

$$m_{4x}(0,\tau,\tau) = \frac{1}{4} P^2 R_c(0,\tau,\tau) \cos(4\pi f_0 \tau) + \frac{1}{2} P^2 R_c(0,\tau,\tau) + 2\sigma_n^2 P R_c(0) + \sigma_n^4 \quad (34)$$

$$m_{4x}(\tau,\tau,\tau) = \left[\frac{3}{4} P^2 R_c(\tau,\tau,\tau) + 3\sigma_n^2 P R_c(\tau) \right] \cos(2\pi f_0 \tau) \quad (35)$$

$$m_{4x}(0,0,\tau) = \left[\frac{3}{4} P^2 R_c(0,0,\tau) + 3\sigma_n^2 P R_c(\tau) \right] \cos(2\pi f_0 \tau) \quad (36)$$

Without any signals, i.e. $x(t) = n(t)$, the fourth-order moments of the noise are

$$m_{4x}(\tau_1, \tau_2, \tau_3) = m_{4n}(\tau_1, \tau_2, \tau_3) = [\delta(\tau_1)\delta(\tau_2 - \tau_3) + \delta(\tau_2)\delta(\tau_1 - \tau_3) + \delta(\tau_3)\delta(\tau_1 - \tau_2)]\sigma_n^4 \quad (37)$$

In this case, four kinds of moments are

$$m_{4x}(0,0,0) = m_{4n}(0,0,0) = 3\sigma_n^4 \quad (38)$$

$$m_{4x}(0,\tau,\tau) = m_{4n}(0,\tau,\tau) = \sigma_n^4 \quad (39)$$

$$m_{4x}(\tau,\tau,\tau) = m_{4n}(\tau,\tau,\tau) = 0 \quad (40)$$

$$m_{4x}(0,0,\tau) = m_{4n}(0,0,\tau) = 0 \quad (41)$$

In the presence of DSSS signal, above equations are not zero and we use them to prove the existence of the DSSS signal.

The authors in [25] improved the detection performance in the frequency

domain detection methods. Also, they showed the methods based on $m_{4x}(\tau, \tau, \tau)$ and $m_{4x}(0, 0, \tau)$ have almost the same performances, whose detection probability is about 50% at -20dB SNR. Furthermore, the frequency domain detection performance is 8dB better than the time domain detection and accumulation method improved about 5 dB in the detection process [25]. But, because of the complex computation, we propose a modified method to decrease the processing time.

Application of improved secant diagonal updating scheme

To solve the problem of nonlinear equations, we usually use the Newton-like methods that the diagonal updating scheme is among the cheapest Newton-like methods [6].

The authors in [6] proposed an improved matrix-free secant updating scheme via line search strategies, by using the steps of back tracking in the Armijo-type line search as a step length predictor and Wolfe-Like condition as corrector. In this scheme, the updating matrix is singular or nearly singular. We use this method to remedy the nonlinear problem of frequency domain fourth order cumulant and process time improvement.

Numerical experiments show that the proposed method is very efficient. This new method produces a sequence of $\{x_k\}$ as bellow:

$$x_{k+1} = x_k - \alpha_k B_k F(x_k) \quad (42)$$

where α_k is step length and B_k is a diagonal approximation of the inverse Jacobian matrix. In this paper, we use a simple line search strategy, which has less computational

operations, floating points operations and CPU time consumptions compared to the classical Armijor line search. These advantages lead to decrement of the iterations number and processing time.

Numerical results, simulations and conclusion

In this section, we illustrate the performance of the proposed method to solve the complex computation problem of frequency domain fourth-order cumulant scheme for DSSS signals. We simulate our proposed method with MATLAB using double precision computer, and the stopping rule:

$$\|x_k\| + \|F_{(x_k)}\| \leq 10^{-4} \quad (43)$$

In this paper, we have these assumptions for codes to terminate whenever one of the following happens:

The number of iterations is at least 2660 CPU will stop after 20 seconds

Sufficient memory for running the program

The performances of these methods have been compared in terms of iterations number and CPU time. Table 1 shows the comparison of the iterations number and CPU processing time for the proposed method and classical cumulant method.

TABLE1. The number of iterations and CPU time for two methods.

| Comparison table | NI | CPU time | DIM |
|---------------------------|------|----------|-----|
| Classical cumulant method | 2400 | 8.95 s | 2 |
| Proposed method | 690 | 2.63 s | 2 |

Dim denotes the system dimension and NI denotes the number of iterations. We analyze the performance of each method via execution time. We observe that diagonal secant updating frequency domain fourth-Order cumulant method has smaller iterations number compared to the cumulant method. This shows that the line search strategies, used in this paper, have increased the speed of processing with respect to the classical cumulant method.

4. CONCLUSIONS

In this paper, with an asymptotic estimating technique, based on 2-D slices fourth-order cumulant, an efficient algorithm was proposed to strongly decrease processing time and computations complexity. As a result, this method can be used for the DSSS detection systems with online processing.

This new method with a title of enhanced diagonal secant updating scheme is based on the steps of backtracking improved via Wolfe-like condition in the Armijo-type line search to solve nonlinear equation of frequency domain 2-D slices fourth-order cumulant method. This method only requires to store a row vector while ignoring all the low and diagonal elements and therefore the required memory is reduced strongly .

This method has very good solving speed and a better performance among the Newton-like methods. Also, this method estimates carrier frequency and symbol rate simultaneously in the online processing. Simulation results and computation analysis indicated that processing time of the modified frequency domain fourth-order cumulant method is better than the commonly used frequency domain fourth-

order cumulant methods. The validity of this method was shown by the computer simulation especially in low signal-to-noise ratio (SNR) conditions.

REFERENCES

- [1] R. L. Picholtz, D. L. Schilling and L. B. Milstein: "Theory of Spread-Spectrum Communications- A Tutorial", *IEEE Trans. on Communications*, Vol. COM- 30, No. 5, pp. 855- 884, May. 1982.
- [2] Deng Li and Yang Shuang, "Improved Method of DSSS Signal Parameter Estimation," 2nd Int. Conf. on Industrial and Information Systems, pp. 301-303, 2010.
- [3] Y. J. Dong, G. Wei, and L. Mu: "Cyclic Spectrum-based DS/SS Signal Detection and Parameter Estimation", *Journal of University of Electronic Science and Technology of China*, vol. 25, pp. 439-443, 1996.
- [4] H. Urkowitz: "Energy Detection of Unknown Deterministic", *Proc IEEE*, 55(4), pp. 523-531, 1967.
- [5] D. V. Sarwate, M. B. Pursley: "Cross correlation Properties of Pseudo random and Related Sequences", *IEEE Proceedings*, vol. 68, pp. 593- 619, No. 5, May. 1980.
- [6] M. Y. Waziri and Z. A. Majid, "Enhanced Matrix-Free Secant Method via Predictor-Corrector Modified Line Search Strategies for Solving Systems of Nonlinear Equations," *International Journal of Mathematics and Mathematical Sciences* Volume 2013, Article ID 814587, 2013.

- [7] J. F. Oberst, D. L. Schilling, "The SNR of a frequency doubler," *IEEE Trans. Comm. Technol (TCOM)*, vol. 19, pp. 97-99, Feb. 1971.
- [8] G. Canovai, G. Corazza: "SNR at the output of a frequency doubler and quadrupler", *Aka FreqL*, vol. XLI, pp. 646-655, Sep. 1972.
- [9] Y. Yao and H. V. Poor: "Blind Detection of Synchronous CDMA in Non-Gaussian Channels", *IEEE Trans. on Signal Processing*, Vol. 52, No. 1, January. 2004.
- [10] G. Canovai and G. Corazza: "Spectrum of the signal at the output of a frequency multiplier or carrier recovery in PSK systems", *Alta Freci*, vol. XLI, pp. 637-645, Sep. 1972.
- [11] W. A. Gardner: "Signal Interception: Performance Advantages of Cyclic-Feature Detectors", *IEEE trans on Commu*, pp. 149-159, 1992.
- [12] J. F. KUEHLS and E. GERANIOTS: "Presence Detection of Binary-Phase-Shift-Keyed and Direct-Sequence Spread-Spectrum Signals Using a Prefilter-Delay-and-Multiply Device", *IEEE Journal on Selected Areas in Communications*, VOL. 8, NO.5, pp. 915-933, June. 1990.
- [13] C. M. Spooner and W. A. Gardner: "Robust feature detection for signal interception", *IEEE Trans. Commun*, vol. 42, pp. 2165-2173, May. 1994.
- [14] D. A. Hill and J. B. Bodie: "Experimental carrier detection of BPSK and QPSK direct sequence spread spectrum signals", In *Conf. Rec. MILCOM'95*, vol. 1, pp. 362-367, Nov. 1995.
- [15] J. C. Imbeaux: "Performances of the delay-line multiplier circuit for clock and carrier synchronization in digital satellite communications", *IEEE J. Select. Areas Comm.*, vol. SAC-1, pp. 82-95, Jan. 1983.
- [16] D. E. Reed and M. A. Wickert: "Spread spectrum signals with low Probability of chip rate detection", *IEEE J. Select. Areas on Comm.*, vol. 7, pp. 595-601, May. 1989.
- [17] aC. M. Spooner and W. A. Gardner: "Robust Feature Detection for Signal Interception", *IEEE Trans. Comm.* vol. COM-42, pp. 2165-2173, May. 1994.
- [18] J. F. Kuehls and E. Geraniotis: "Presence detection of binary phase shift keyed and direct sequence spread spectrum signals using a prefilter delay and multiply device", *IEEE J. Selected Areas on Comm.*, vol. SAC-8, pp. 915-933, June. 1990.
- [19] G. Burel: "Detection of spread spectrum transmissions using fluctuations of correlation estimators", *IEEE-ISPACS*, pp. 5-8, Nov. 2000.
- [20] G. Burel, R. Gautier and C. N. Nzeza: "Blind Multiuser Detection in Multirate CDMA Transmissions Using Fluctuations of Correlation Estimators", *IEEE Global Telecommunications Conference (GLOBECOM '06)*, PP. 1-5, 2006.
- [21] P. Y. Qiu, D. Xu, Z. T. Huang and W. Jiang: "Blind Spreading Sequence Set Estimation of the M-ary Direct Sequence Spread Spectrum Signals" , in *IEEE Wireless Communications, Networking and Information Security (WCINS)*, pp. 188-191, Nov. 2010.

- [22] G. Burel, "Detection of spread spectrum transmission using fluctuations of correlation estimators," in *IEEE Int. Symp. On Intelligent Signal Processing and Communications Systems (ISPAC'2000)*, Honolulu, Hawaii, USA, November 5-8, 2000.
- [23] X. L. Zhang, J. T. Xu and Y. S. Chen: "Detection of BPSK DS Signal Based on Cyclic Spectrum Correlation Technology", *Information Technology (in Chinese)*, No. 8, pp. 30-32, 2004.
- [24] aZ. Shen, B. Tang, Y. Lv and X. Zhu: "Multiple Parameters Estimation Simultaneously for DS-SS/BPSK Signal Based on Fourth-Order Cumulant 2-D Slice", *IEEE Communications Circuits and Systems (ICCCAS)*, vol. 2, pp. 867-870. 2004.
- [25] Z. Zhao, G. Xing and J. Wu: "The Detection Methods Based on the Fourth-order Moment Slices and the Accumulation for DSSS/QPSK Signal", *IEEE 8th International Conference on Signal Processing (ICOSP)*, vol. 4, 2006.
- [26] Y. Shuang, D. Li, "Improved Method of DSSS Signal Parameter Estimation" *International Conference on Industrial and Information Systems*, vol. 2, pp. 301-303. 2010.
- [27] X. M. Zhng and Z. Z. Zhang, "Parameter Estimation of DSSS Signals with Modified Fourth-Order Cumulants," *IEEE Innovative Computing, Information and Control (ICICIC '06)*, vol. 1, pp. 126-129, 2006.