



## Maximum Power Point Tracking Methods Used in Photovoltaic Systems: A Review

Ali Moghassemi<sup>1</sup>, Shayan Ebrahimi<sup>1</sup>, Javad Olamaei<sup>1\*</sup>

<sup>1</sup> Department of Electrical Engineering, South Tehran Branch, Islamic Azad University, Tehran, Iran.

Received: 29-Sep-2019, Revised: 16-Dec-2019, Accepted: 22-Dec-2019.

### Abstract

This paper reviews and compares the most important maximum power point tracking (MPPT) techniques used in photovoltaic systems. There is an abundance of techniques to enhance the efficiency of photovoltaic systems. The crucial distinctions between these techniques are digital or analog implementation, simplicity of the design, sensor requirements, convergence speed, stability, range of effectiveness and costs. Thus, opting for a suitable algorithm is vital as it affects the electrical efficiency of the PV system and lowers the costs by lessening the number of solar panels needed to get the desired power. Moreover, the paper provided a summary of the most used MPPT algorithms.

**Keywords:** PV System, MPPT, Power, Speed, Efficiency.

### 1. INTRODUCTION

Maximum Power Point Tracking (MPPT) operates Solar PV modules in a manner that allows the modules to produce all the power that they are capable of generating. MPPT is not a mechanical tracking system but it works on a particular tracking algorithm and is based on a control system. MPPT can be used in conjunction with a mechanical tracking

system, but the two systems are completely different. MPPT algorithms are used to obtain the maximum power from the solar array based on the variation in the irradiation and temperature. The voltage at which the PV module can produce maximum power is called 'maximum power point' (or peak power voltage). Maximum power varies with solar radiation, ambient temperature and solar cell temperature [1]. Over the past decades, many methods for finding the MPP

---

\*Corresponding Authors Email:  
j\_olamaei@azad.ac.ir

have been developed [2]. These techniques differ in many aspects such as required sensors, complexity, cost, range of effectiveness, convergence speed, correct tracking when irradiation and/or temperature change, hardware needed for the implementation or popularity, among others. Some of the most popular MPPT techniques are [3]: Perturb and Observe (Hill-Climbing method), Incremental Conductance method, Fractional Short Circuit Current, Fractional Open-Circuit Voltage, Fuzzy Logic, Neural Networks, Ripple Correlation Control, Current Sweep, DC-Link Capacitor Droop Control, Load Current or Load Voltage Maximization, and  $dP/dV$  or  $dP/dI$  Feedback Control.

Among several techniques mentioned, the Perturb and Observe (P&O) methods and the Incremental Conductance (IC) algorithms are the most commonly applicable algorithms. Other techniques based on different principles include fuzzy logic control, neural network, fractional open circuit voltage or short circuit current, current sweep, etc. Most of which yield a local maximum and some, like the fractional open circuit voltage or short circuit current, give an approximated MPP rather than an exact output. In normal conditions, the V-P curve has only one maximum. However, if the PV array is partially shaded, there are multiple maxima in these curves.

Both P&O and IC algorithms are based on the “hill-climbing” principle, which consists of moving the operation point of the PV array in the direction in which the power increases. Hill-climbing techniques are the most popular MPPT methods due to their ease of implementation and good

performance when the irradiation is constant. The advantages of both methods are simplicity and requirement of low computational power. The drawbacks are oscillations occurring around the MPP and they get lost and track the MPP in the wrong direction during rapid changing atmospheric conditions [4].

## 2. MPPT ALGORITHMS

### 2.1. Perturb and Observe

In the P&O method, only one voltage sensor is used to sense the PV array voltage and hence the cost of implementation is less. The algorithm involves a perturbation on the duty cycle of the power converter and a perturbation in the operating voltage of the DC-link between the PV array and the power converter. Perturbing the duty cycle of the power converter implies modifying the voltage of the DC-link between the PV array and the power converter. In this method, the sign of the last perturbation and the sign of the last increment in the power are used to decide the next perturbation. As can be seen in Fig. 1, on the left of the MPP incrementing, the voltage increases the power whereas on the right decrementing, the voltage decreases the power. If there is an increment in the power, the perturbation should be kept in the same direction and if the power decreases, then the next perturbation should be in the opposite direction. Based on these facts, the algorithm is implemented as shown in the flowchart in Fig. 2 and the process is repeated until the MPP is reached. The operating point oscillates around the MPP [5].

The time complexity of this algorithm is very less but on reaching very close to the

MPP, it doesn't stop at the MPP and keeps on perturbing on both the directions. To avoid such a condition, an appropriate error limit can be set or a wait function can be used to stop the increase in time complexity of the algorithm. However, the method does not

take account of the rapid change of irradiation level (due to which MPPT changes) and considers it as a change in MPP due to perturbation and ends up calculating the wrong MPP. To avoid this problem, we can use the incremental conductance method.

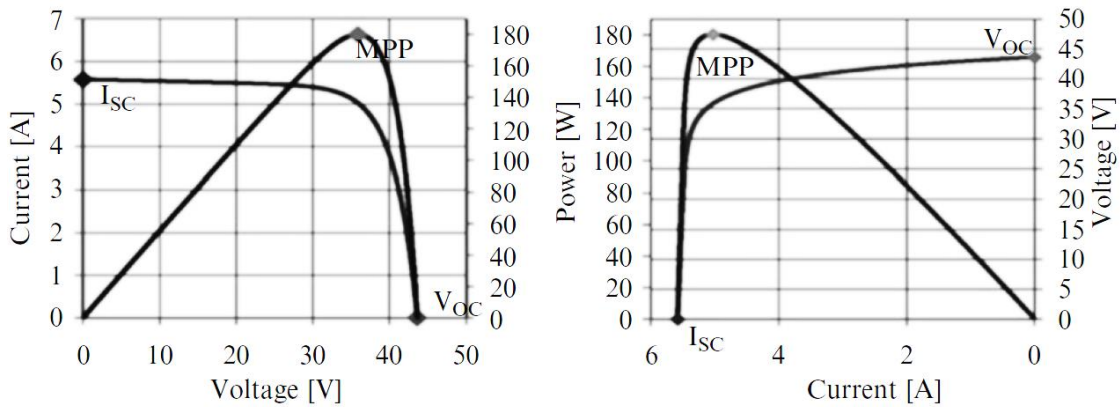

Fig. 1. PV panel characteristic curves.

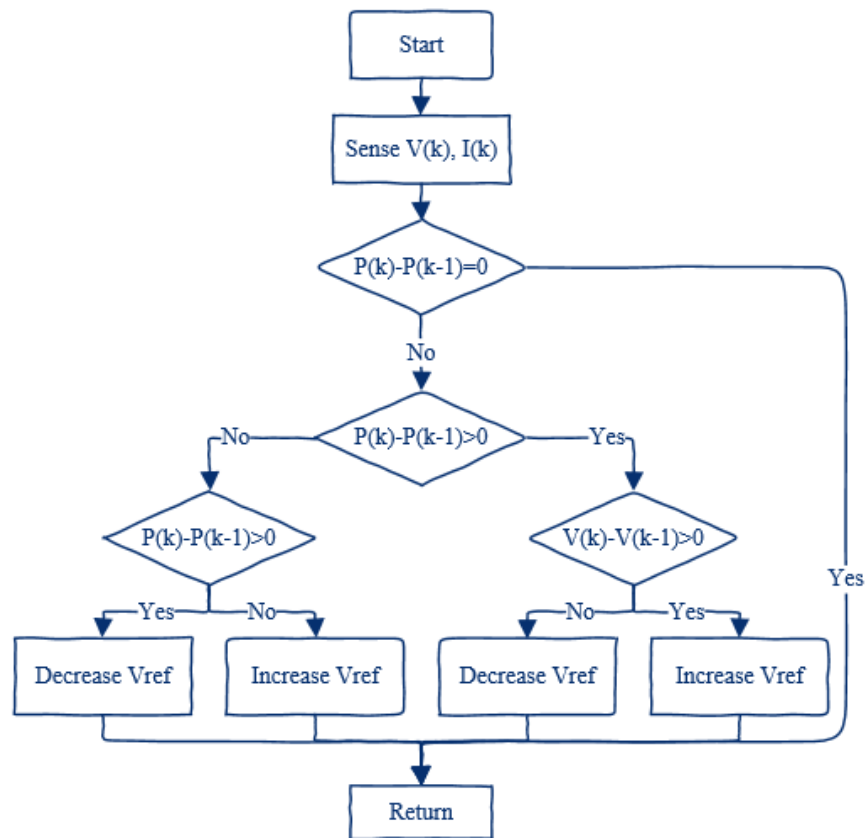

Fig. 2. Flowchart of the perturb and observe algorithm.

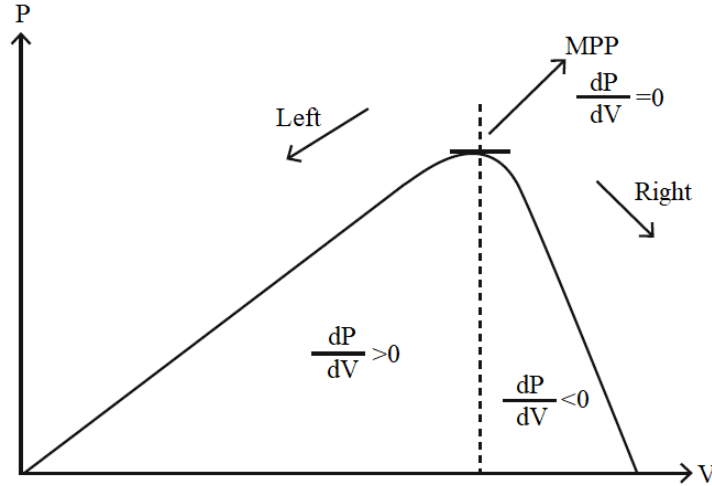

Fig. 3. Basic idea of incremental conductance method on a P-V curve of solar module.

## 2.2. Incremental Conductance

The incremental conductance algorithm uses two voltage and current sensors to sense the output voltage and current of the PV array. In the incremental conductance method, the array terminal voltage is always adjusted according to the MPP voltage which is based on the incremental and instantaneous conductance of the PV module.

Figure 3 shows that the slope of the P-V array power curve is zero at the MPP, increasing on the left of the MPP and decreasing on the right-hand side of the MPP. The basic equations of this method are as follows:

$$\begin{aligned} \frac{dP}{dV} = 0 &\Rightarrow \frac{I}{V} = \frac{-dI}{dV} && \Rightarrow \text{at the MPP} \\ \frac{dP}{dV} > 0 &\Rightarrow \frac{I}{V} > \frac{-dI}{dV} && \Rightarrow \text{left of the MPP} \\ \frac{dP}{dV} < 0 &\Rightarrow \frac{I}{V} < \frac{-dI}{dV} && \Rightarrow \text{right of the MPP} \end{aligned} \quad (1)$$

where  $I$  and  $V$  are P-V array output current and voltage respectively. The left-hand side of equations represents incremental conductance of P-V module and the right-hand side represents the instantaneous conductance [5].

When the ratio of change in output conductance is equal to the negative output conductance, the solar array will operate at the maximum power point. This method exploits the assumption of the ratio of change in output conductance is equal to the negative output Instantaneous conductance. We have:  $P = VI$ . Applying the chain rule for the derivative of products yields to:

$$\frac{\partial P}{\partial V} = \frac{\partial(VI)}{\partial V} \quad (2)$$

At MPP, as  $\partial P/\partial V = 0$ . The above equation could be written in terms of array voltage  $V$  and array current  $I$  as:

$$\frac{\partial P}{\partial V} = -\frac{I}{V} \quad (3)$$

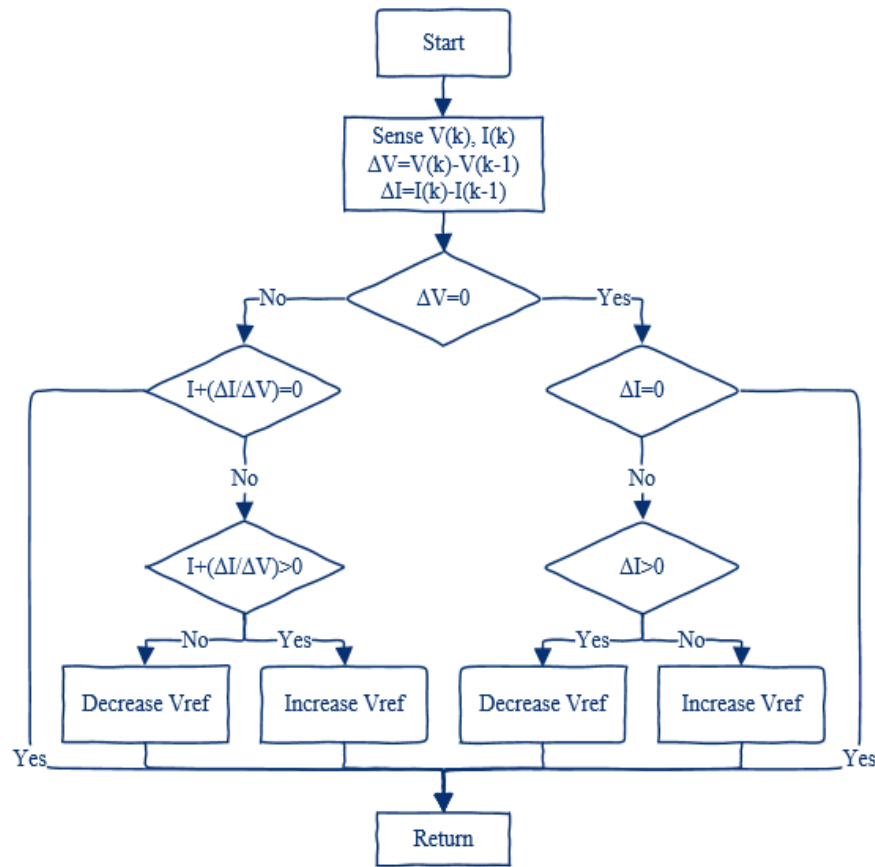

Fig. 4. Flow chart for incremental conductance algorithm.

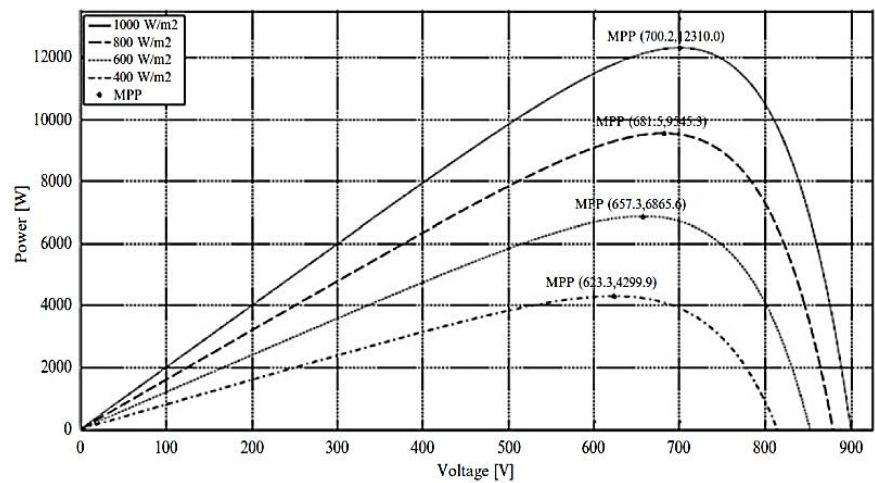

Fig. 5. P-V curve depending on the irradiation.

The MPPT regulates the PWM control signal of the DC/DC boost converter until the condition:  $(\partial I/\partial V) + I/V = 0$  is satisfied. In

this method, the peak power of the module lies at above 98 % of its incremental

conductance. The Flow chart of incremental conductance MPPT is shown in Fig. 4.

In both P&O and IC schemes, the speed of occurrence of MPP depends on the size of the increment of the reference voltage. There are two drawbacks outlined as follows: The first drawback is that they can easily lose track of the MPP if the irradiation changes rapidly. In case of step changes, they track the MPP very well because the change is instantaneous and the curve does not keep on changing. However, when the irradiation changes following a slope, the curve in which the algorithms are based on changes continuously with the irradiation, as can be seen in Fig. 5. So the changes in the voltage and current are not only due to the perturbation of the voltage. As a consequence, the algorithms cannot determine whether the change in the power is due to its voltage increment or the change in the irradiation.

The other drawback of both methods is the oscillations of the voltage and current around the MPP in the steady-state. This is because the control is discrete and the voltage and current are not constant at the MPP but oscillating around it. The size of the oscillations depends on the size of the rate of change of the reference voltage. The greater the oscillation, the higher is the amplitude of the oscillations. However, the speed of the MPP occurrence also depends on this rate of change and this dependence is inversely proportional to the size of the voltage increments. The traditional solution is a tradeoff: if the increment is small, the oscillations will decrease, then the MPP is reached slowly and vice versa. Therefore, a compromise solution has to be found.

### 2.3. Fractional Open-Circuit Voltage

The near-linear relationship between  $V_{MPP}$  and  $V_{OC}$  of the PV array, under varying irradiance and temperature levels, has given rise to the fractional  $V_{OC}$  method:

$$V_{MPP} \approx k_1 V_{OC} \quad (4)$$

where,  $k_1$  is a constant of proportionality. Since  $k_1$  is dependent on the characteristics of the PV array being used, it usually has to be computed beforehand by empirically determining  $V_{MPP}$  and  $V_{OC}$  for the specific PV array at different irradiance and temperature levels. The factor  $k_1$  has been reported to be between 0.71 and 0.78. Once  $k_1$  is known,  $V_{MPP}$  can be computed using (4) with  $V_{OC}$  measured periodically by momentarily shutting down the power converter. However, this incurs some disadvantages, including temporary loss of power. To prevent this, pilot cells are used from which  $V_{OC}$  can be obtained. These pilot cells must be carefully chosen to closely represent the characteristics of the PV array. Once  $V_{MPP}$  has been approximated, a closed-loop control on the array power converter can be used to asymptotically reach this desired voltage. Since (4) is only an approximation, the PV array technically never operates at the MPP. Depending on the application of the PV system, this can sometimes be adequate. Even if fractional  $V_{OC}$  is not a true MPPT technique, it is very easy and cheap to implement as it does not necessarily require DSP or microcontroller control. However,  $k_1$  is no more valid in the presence of partial shading (which causes multiple local maxima) of the PV array and proposes sweeping the PV array voltage to update  $k_1$ .

This adds to the implementation complexity and incurs more power loss [6].

## 2.4. Fractional Short-Circuit Current

Fractional  $I_{SC}$  results from the fact that, under varying atmospheric conditions,  $I_{MPP}$  is approximately linearly related to the  $I_{SC}$  of the PV array:

$$I_{MPP} \approx k_2 I_{SC} \quad (5)$$

where,  $k_2$  is a proportionality constant. Just like in the fractional  $V_{OC}$  technique,  $k_2$  has to be determined according to the PV array in use. The constant  $k_2$  is generally found to be between 0.78 and 0.92. Measuring  $I_{SC}$  during operation is problematic. An extra switch usually has to be added to the power converter to periodically short the PV array so that  $I_{SC}$  can be measured using a current sensor. This increases the number of components and costs. Not only power output is reduced when finding  $I_{SC}$  but also because the MPP is never perfectly matched as suggested by (5), the variable  $k_2$  can be compensated such that the MPP is better tracked while atmospheric conditions change. To guarantee proper MPPT in the presence of multiple local maxima, the PV array voltage from open-circuit to short-circuit periodically sweeps to update  $k_2$ .

Most of the PV systems using fractional  $I_{SC}$  in the literature use a DSP, while a few systems use a simple current feedback control loop instead [6].

## 2.5. Fuzzy Logic Control

Microcontrollers have made using fuzzy logic control popular for MPPT over the last decade. Fuzzy logic controllers have the advantages of working with imprecise inputs, not needing an accurate mathematical model, and handling nonlinearity. Fuzzy logic control generally consists of three stages: fuzzification, rule base table lookup, and defuzzification. During fuzzification, numerical input variables are converted into linguistic variables based on a membership function similar to Fig. 6.

In some cases, seven fuzzy levels are likely to be used for more accuracy. Fig. 6, *a* and *b* are based on the range of values of the numerical variable. The membership function is sometimes made less symmetric to give more importance to specific fuzzy levels. The inputs to a MPPT fuzzy logic controller are usually an error  $E$  and a change in error  $\Delta E$ . The user has the flexibility of choosing how to compute  $E$  and  $\Delta E$ . Since  $dP/dV$  vanishes at the MPP, an approximation can be applied as follows:

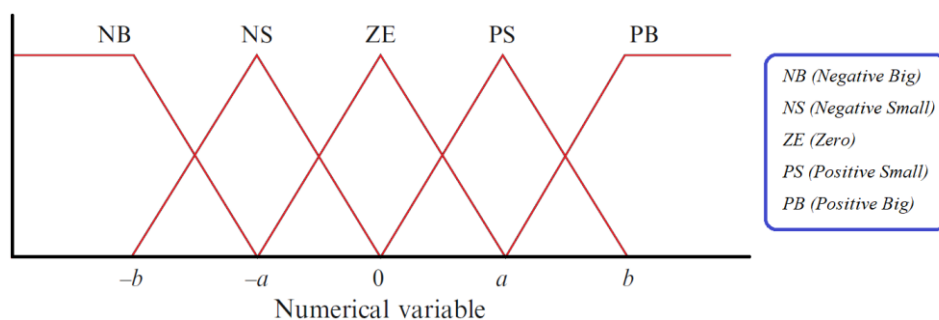

**Fig. 6. Membership function for inputs and output of fuzzy logic controller.**

**Table 1. Fuzzy rule base.**

E	$\Delta E$				
	NB	NS	ZE	PS	PB
NB	ZE	ZE	NB	NB	NB
NS	ZE	ZE	NS	NS	NS
ZE	NS	ZE	ZE	ZE	PS
PS	PS	PS	PS	ZE	ZE
PB	PB	PB	PB	ZE	ZE

$$E(n) = \frac{P(n) - P(n-1)}{V(n) - V(n-1)} \quad (6)$$

and

$$\Delta E(n) = E(n) - E(n-1) \quad (7)$$

Equivalently,  $e = I/V + dI/dV$  is often used. Once  $E$  and  $\Delta E$  are calculated and converted to the linguistic variables, the fuzzy logic controller output, which is typically a change in duty ratio  $\Delta D$  of the power converter, can be looked up in a rule base table such as Table 1. The linguistic variables assigned to  $\Delta D$  for the different combinations of  $E$  and  $\Delta E$  are based on the power converter being used and also on the knowledge of the user. The rule base shown in Table 1 is based on a boost converter. If, for example, the operating point is far to the left of the MPP,  $E$  is  $PB$ , and  $\Delta E$  is  $ZE$ , then we want to increase the duty ratio largely, consequently,  $\Delta D$  should be  $PB$  to reach the MPP. In the defuzzification stage, the fuzzy logic controller output is converted from a linguistic variable to a numerical variable still using a membership function as shown in Fig. 6. This provides an analog signal that

will control the power converter to the MPP. MPPT fuzzy logic controllers have been shown to perform well under varying atmospheric conditions. However, their effectiveness depends a lot on the knowledge of the user or control engineer in choosing the right error computation and coming up with the rule base table [7-8].

## 2.6. Neural Network

Along with fuzzy logic controllers, another technique of implementing MPPT are the neural networks, which are also well adapted for microcontrollers. Neural networks commonly have three layers: input, hidden, and output layers as shown in Fig. 7. The number of nodes in each layer vary and are user-dependent. The input variables can be PV array parameters like  $V_{OC}$  and  $I_{SC}$ , atmospheric data like irradiance and temperature, or any combination of them. The output is usually one or several reference signal(s) like a duty cycle signal used to drive the power converter to operate at or close to the MPP. How close the operating point gets to the MPP depends on the algorithms used by the hidden layer and how well the neural



network has been trained. The links between the nodes are all weighted. The link between nodes  $i$  and  $j$  is labeled as weighting of  $w_{ij}$  in Fig. 7. To accurately identify the MPP, the  $w_{ij}$ 's have to be carefully determined through a training process, whereby the PV array is tested over months or years and the patterns between the input(s) and output(s) of the neural network are recorded. Since most PV arrays have different characteristics, a neural network has to be specifically trained for the PV array with which it will be used. The characteristics of a PV array also change with time, implying that the neural network has to be periodically trained to guarantee accurate MPPT [9].

## 2.7. Ripple Correlation Control

When a PV array is connected to a power converter, the switching action of the power converter imposes voltage and current ripple on the PV array. As a consequence, the PV array power is also subject to ripple. Ripple correlation control (RCC) makes use of ripple to perform MPPT. RCC correlates the time derivative of the time-varying PV array power  $p$  with the time derivative of the time-varying PV array current  $i$  or voltage  $v$  to drive the power gradient to zero, thus

reaching the MPP. Based on the PV array characteristics, if  $v$  or  $i$  increases ( $v > 0$  or  $i > 0$ ) and  $p$  increases ( $p > 0$ ), then the operating point is below the MPP ( $V < V_{MPP}$  or  $I < I_{MPP}$ ). On the other hand, if  $v$  or  $i$  increases and  $p$  decreases ( $p < 0$ ), then the operating point is above the MPP ( $V > V_{MPP}$  or  $I > I_{MPP}$ ). Combining these observations, we see that  $p\dot{v}$  or  $p\dot{i}$  are positive to the left of the MPP, negative to right of the MPP, and zero at the MPP. When the power converter is a boost converter, increasing the duty ratio increases the inductor current, which is the same as the PV array current, but decreases the PV array voltage. Therefore, the duty ratio control input is:

$$d(t) = -k_3 \int p\dot{v} dt \quad (8)$$

or

$$d(t) = k_3 \int p\dot{i} dt \quad (9)$$

where  $k_3$  is a positive constant. Controlling the duty ratio in this fashion assures that the MPP will be continuously tracked, making RCC a true MPP tracker. The derivatives in (8) and (9) are usually undesirable, the AC-coupled measurements of the PV array current and voltage can be used instead since they contain the necessary phase information. The derivatives can also be approximated by high-pass filters with a cutoff frequency higher than the ripple frequency. A different and easy way of obtaining the current derivative in (9) is to sense the inductor voltage, which is proportional to the current derivative. The non-idealities in the inductor (core loss, resistance) have a small effect since the time constant of the inductor is

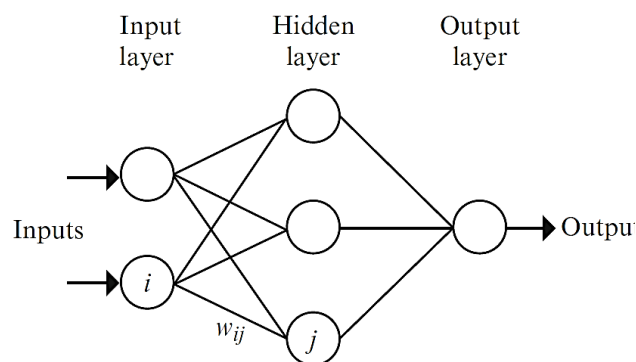

Fig. 7. Example of neural network.

much larger than the switching period in a practical converter. Equation (9) can fail due to the phase shift brought about by the intrinsic capacitance of the PV array at high switching frequencies. However, correlating power and voltage, as in (8), is barely affected by the intrinsic capacitance [10-12].

## 2.8. DC-Link Capacitor Droop Control

DC-link capacitor droop control is a MPPT technique that is specifically designed to work with a PV system. This PV system is connected in parallel with an AC system line as shown in Fig. 8. The duty ratio of an ideal boost converter is given by

$$d = 1 - \frac{V}{V_{link}} \quad (10)$$

where  $V$  is the voltage across the PV array and  $V_{link}$  is the voltage across the DC-link. If  $V_{link}$  is kept constant, increasing the current going in the inverter increases the power coming out of the boost converter and consequently, increases the power coming out of the PV array. While the current is increasing, the voltage  $V_{link}$  can be kept constant as long as the power required by the inverter does not exceed the maximum power

available from the PV array. If that is not the case,  $V_{link}$  starts drooping. Right before that point, the current control command  $I_{peak}$  of the inverter is at its maximum and the PV array operates at the MPP. The AC system line current is feedback to prevent  $V_{link}$  from drooping and  $d$  is optimized to bring  $I_{peak}$  to its maximum, thus achieving MPPT. DC-link capacitor droop control does not require the computation of the PV array power, but its response deteriorates when compared to a method that detects the power directly; this happens because its response directly depends on the response of the DC voltage control loop of the inverter. This control scheme can be easily implemented with analog operational amplifiers and decision-making logic units [13-14].

## 2.9. Load Current or Voltage Maximization

The purpose of MPPT techniques is to maximize the power coming out of a PV array. When the PV array is connected to a power converter, maximizing the PV array power also maximizes the output power at the load of the converter. Conversely, maximizing the output power of the

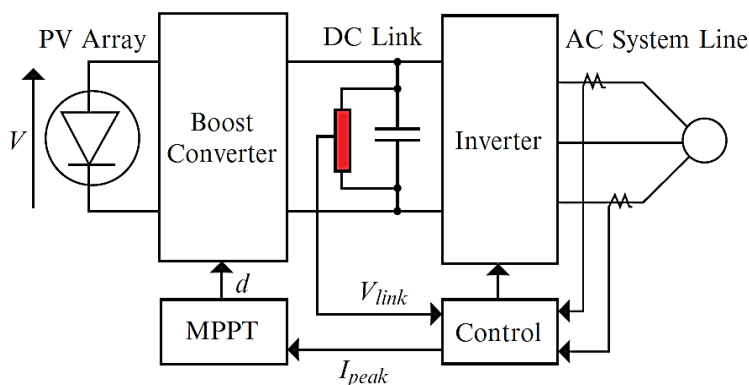

Fig. 8. Topology for DC-link capacitor droop control.

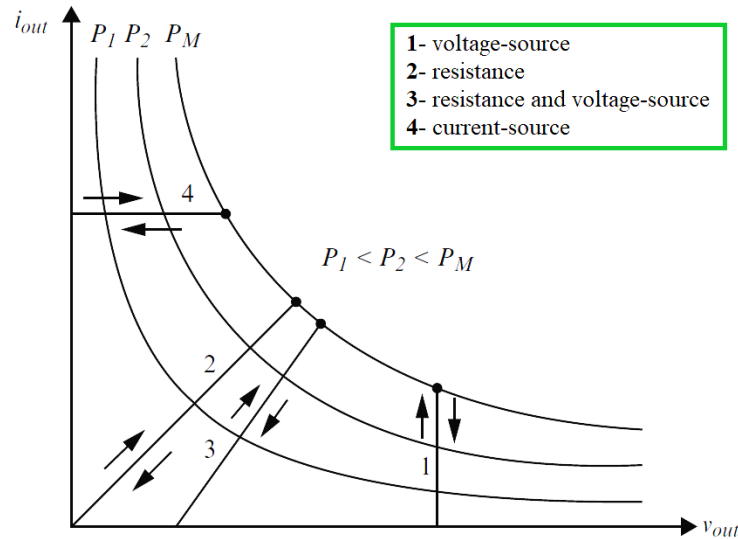

Fig. 9. Different load types.

converter should maximize the PV array power, assuming a lossless converter. Most loads can be of voltage source type, current-source type, a resistive type, or a combination of these, as shown in Fig. 9.

From this figure, it is clear that for a voltage-source type load and the load current  $i_{out}$  should be maximized to reach the maximum output power  $PM$ . For a current-source type load, the load voltage  $v_{out}$  should be maximized. For the other load types, either  $i_{out}$  or  $v_{out}$  can be used. This is also true for nonlinear load types as long as they do not exhibit negative impedance characteristics. Therefore, for almost all loads of interest, it is adequate to maximize either the load current or the load voltage to maximize the load power. Consequently, only one sensor is needed. In most PV systems, a battery is used as the main load or as a backup. Since a battery can be thought of as a voltage-source type load, the load current can be used as the control variable. Positive feedback can also be used to control the power converter such that the load current is maximized and the PV

array operates close to the MPP. Exact operation at the MPP is seldom achieved because this MPPT method is based on the assumption that the power converter is lossless [15-16].

### 3. DISCUSSION

#### 3.1. Implementation

The ease of implementation is an important factor in deciding which MPPT technique to be used. However, this greatly depends on the end-user's knowledge. Some might be more familiar with analog circuitry, in that case, fractional  $I_{SC}$  or  $V_{OC}$ , RCC, and load current or voltage maximization are good options. Others might be willing to work with digital circuitry, even if that may require the use of software and programming. Then, their selection should include hill-climbing/ P&O, IC, fuzzy logic control, neural network, and  $dP/dV$  or  $dP/dI$  feedback control. Furthermore, a few of the MPPT techniques only apply to specific topologies. For example, the DC-link capacitor droop control

works with the system shown in Fig. 8, and the OCC MPPT works with a single-stage inverter.

### 3.2. Sensors

The number of sensors required to implement MPPT also affects the decision process. Most of the time, it is easier and more reliable to measure voltage than current. Moreover, current sensors are usually expensive and bulky. This might be inconvenient in systems that consist of several PV arrays with separate MPP trackers. In such cases, it might be wise to use MPPT methods that require only one sensor that can estimate the current from the voltage. It is also uncommon to find sensors that measure irradiance levels, as needed in the linear current control and the  $I_{MPP}$  and  $V_{MPP}$  computation methods.

### 3.3. Multiple Local Maxima

The occurrence of multiple local maxima due to partial shading of the PV array (s) can be a real hindrance to the proper functioning of the MPP tracker. Considerable power loss can be incurred if a local maximum is tracked instead of the real MPP. As mentioned previously, the current sweep and the state-based methods should track the true MPP even in the presence of multiple local maxima. However, the other methods require an additional initial stage to bypass the unwanted local maxima and bring the operation to close the real MPP.

### 3.4. Costs

It is hard to mention the monetary costs of every single MPPT technique unless it is built and implemented. However, a good costs

comparison can be made by knowing whether the technique is analog or digital, whether it requires software and programming, and the number of sensors. Analog implementation is generally cheaper than digital, which normally involves a microcontroller that needs to be programmed. Eliminating current sensors considerably drops the costs.

### 3.5. Applications

Different MPPT techniques discussed above will suit different applications. For example, in space satellites and orbital stations that involve a large amount of money, the costs and complexity of the MPP tracker are not as important as its performance and reliability. The tracker should be able to continuously track the true MPP in a minimum amount of time and should not require periodic tuning. In this case, hill climbing/P&O, IC, and RCC are appropriate. Solar vehicles would mostly require fast convergence to the MPP. Fuzzy logic control, neural network, and RCC are good options in this case. Since the load in solar vehicles mainly consists of batteries, load current or voltage maximization should also be considered. The goal, when using PV arrays in residential areas, is to minimize the payback time. To do this, it is essential to track the MPP constantly and quickly. Since partial shading (from trees and other buildings) can be an issue, the MPPT should be capable of bypassing multiple local maxima. Therefore, the two-stage IC and the current sweep methods are suitable. Since a residential system might also include an inverter, the OCC MPPT can also be used. PV systems used for street lighting only

**TABLE 2. Comparison of the most used MPPT algorithms.**

No.	MPPT	PV Array Dependence	True MPPT	A/D	Periodic Tuning	Speed	Complexity	Stability	Sensors
1	P&O [17-20]	N	Y	A/D	N	Varies	Low	Not stable	V.I
2	IC [19-24]	N	Y	D	N	Varies	Medium	Not stable	V.I
3	Fractional $V_{OC}$ [19-20, 24-25]	Y	N	A/D	Y	Medium	Low	Not stable	V
4	Fractional $I_{SC}$ [19-20, 24-25]	Y	N	A/D	Y	Medium	Medium	Not stable	I
5	FLC [19-20, 27-30]	Y	Y	D	Y	Fast	High	Very stable	Varies
6	NN [20,27]	Y	Y	D	Y	Fast	High	Very stable	Varies
7	RCC [3,27]	N	Y	A	N	Fast	Low	Very stable	V.I
8	Current Sweep [27]	Y	Y	D	Y	Slow	High	Stable	V.I
9	DC-Link Capacitor Droop Control [27]	N	N	A/D	N	Medium	Low	Stable	V
10	Load $I$ or $V$ Maximization [27]	N	N	A	N	Fast	Low	Not stable	V.I
11	$dP/dV$ or $dP/dI$ Feedback Control [27]	N	Y	D	N	Fast	Medium	Stable	V.I
12	$\beta$ Method [27]	Y	Y	D	N	Fast	High	Stable	V.I
13	Constant Voltage Tracker [27, 31]	Y	N	D	Y	Medium	low	Not stable	V
14	Look up Table [27, 32]	Y	Y	D	Y	Fast	Medium	Depends on memory	V.I.T
15	Online [27]	N	Y	D	N	Fast	High	Stable	V.I
16	Linear Current Control [27, 33]	Y	N	D	Y	Fast	Medium	Stable	Ir
17	IMPP & VMPP Computation [34]	Y	Y	D	Y	N/A	Medium	Not stable	Ir.T
18	State Based [27]	Y	Y	A/D	Y	Fast	High	Stable	V.I
19	BFV [27]	Y	N	A/D	Y	N/A	Low	Not stable	None
20	LRCM [5]	Y	N	D	N	N/A	High	Stable	V.I
21	SC [21, 23-45]	N	Y	D	N	Fast	Medium	Stable	V.I
22	Temperature [27, 38, 46]	Y	Y	D	Y	Medium	Low	Not stable	V.T

23	IC-PI [46-47]	N	Y	D	N	Fast	Medium	Not stable	V.I
24	Three Point Weight Comparison [27, 39, 48]	N	Y	D	N	Low	Low	Stable	V.I
25	POS [27]	N	Y	D	N	N/A	Low	Not stable	I
26	Biological Swarm Chasing [27]	N	Y	D	N	Varies	High	Very Stable	V. I. T. Ir
27	Variable Inductor [27]	N	Y	D	N	Varies	Medium	Not stable	V.I
28	INR [27]	N	Y	D	N	Fast	Medium	Stable	V.I
29	Parasitic Capacitances [24, 49-50]	N	Y	A	N	Fast	Low	Stable	V.I
30	Modified IC [51]	N	Y	D	N	Medium	High	Not stable	V.I
31	Pilot Cell [52]	Y	N	A/D	Y	Medium	Low	Not stable	V.I
32	Modified P&O [53]	N	Y	D	N	Fast	Medium	Not stable	V.I
33	Estimate Perturb-Perturb [43, 53-55]	N	Y	D	N	Fast	Medium	Stable	V.I
34	QI [55-56]	N	Y	D	N	Fast	Medium	Stable	V.I
35	PSO [47, 58-59]	N	Y	D	N	Fast	Low	Very stable	V.I
36	PSO-IC [59]	N	Y	D	N	Fast	Low	Very stable	V.I
37	COS [60]	N	Y	D	N	Fast	Medium	Not stable	V.I
38	SA [61]	Y	Y	D	N	Fast	High	Very stable	V.I
39	ANN-P&O [20, 62-63]	N	Y	D	N	Fast	Medium	Very stable	V.I
40	ACO [64, 65]	N	Y	D	N	Fast	Medium	Stable	V.I
41	ESM [66]	N	Y	A/D	N	Fast	Medium	Stable	V.I
42	Gauss-Newton [67]	N	Y	D	N	Fast	Low	May diverge	V.I
43	Steepest-Descent [67]	N	Y	D	N	Fast	Medium	Stable	V.I
44	Analytic [68, 69]	Y	N	A/D	Y	Medium	High	Stable	V.I
45	Newton-Like Extremum Seeking Control [70]	N	Y	A	N	Fast	High	May diverge	V
46	GA-ANN [73]	N	Y	D	Y	Fast	High	Very stable	V. T. Ir
47	DE [20]	N	Y	D	N	Fast	Low	Very stable	V.I

consist of charging up batteries during the day. They do not necessarily need tight constraints; easy and cheap implementation might be more important, making fractional  $V_{OC}$  or  $I_{SC}$  viable. Table 2 summarizes the major characteristics of the most used MPPT techniques.

#### 4. CONCLUSION

In this paper, a brief description and comparison of maximum power point tracking (MPPT) algorithms has been presented. All the most important features are summarized in Table 2. The dependency of the parameters, digital or analog implementation, convergence speed, the complexity or simplicity of the system, number of sensors and tuning, are considered as the parameters to compare with one another. It would be helpful and worthwhile to select a better and eminently suitable algorithm according to the desired characteristics. Moreover, this paper is provided the most commonly used MPPT algorithms.

#### REFERENCES

- [1] J. Olamaei, S. Ebrahimi, A. Moghassemi, Compensation of Voltage Sag Caused by Partial Shading in Grid-Connected PV System Through the Three-Level SVM Inverter, *Sustainable Energy Technology & Assessments* 18 (2016) 107-118.
- [2] Jun Qi, Youbing Zhang, Yi Chen, Modeling and Maximum Power Point Tracking (MPPT) Method for PV Array Under Partial Shade Conditions, *Renewable Energy* 66 (2014) 337-345.
- [3] Nabil Karami, Nazih Moubayed, Rachid Outbib, General Review and Classification of Different MPPT Techniques, *Renewable and Sustainable Energy Reviews* 68(1) (2017) 1-18.
- [4] Boualem Bendib, Hocine Belmili, Fateh Krim, A Survey of the Most Used MPPT Methods: Conventional and Advanced Algorithms Applied for Photovoltaic Systems, *Renewable and Sustainable Energy Reviews* 45 (2015) 637-648.
- [5] B. Subudhi, R. Pradhan, A Comparative Study on Maximum Power Point Tracking Techniques for Photovoltaic Power Systems, *IEEE Transactions on Sustainable Energy* 4(1) (2013) 89-98,.
- [6] Ehtisham Lodhi, Zeeshan Lodhi, Rana Noman Shafqat, Fieda Chen, Performance Analysis of Perturb and Observe and Incremental Conductance MPPT Algorithms for PV System, *IOP Conference Series: Materials Science and Engineering* 220 (2017) 1-5.
- [7] Pratima Das, Maximum Power Tracking Based Open Circuit Voltage Method for PV System, 5th International Conference on Advances in Energy Research, ICAER 90 (2016) 2-13.
- [8] S. Narendiran, S. K. Sahoo, R. Das, A. K. Sahoo, Fuzzy Logic Controller Based Maximum Power Point Tracking for PV System, 3rd International Conference on Electrical

- Energy Systems (ICEES), Chennai (2016) 29-34.
- [9] Saban Ozdemir, Necmi Altin, Ibrahim Sefa, Fuzzy Logic Based MPPT Controller for High Conversion Ratio Quadratic Boost Converter, *International Journal of Hydrogen Energy* 42(28) (2017) 17748-17759.
- [10] Sabir Messalti, Abdelghani Harrag, Abdelhamid Loukriz, A New Variable Step Size Neural Networks MPPT Controller: Review, Simulation and Hardware Implementation, *Renewable and Sustainable Energy Reviews* 68(1) (2017) 221-233.
- [11] Ch. L.S. Srinivas, E.S. Sreeraj, A Maximum Power Point Tracking Technique Based on Ripple Correlation Control for Single Phase Photovoltaic System with Fuzzy Logic Controller, *Energy Procedia* 90 (2016) 69-77.
- [12] A. Trivedi, A. Gupta, R. K. Pachauri, Y. K. Chauhan, Comparison of Perturb & Observe and Ripple Correlation Control MPPT Algorithms for PV Array, *IEEE 1st International Conference on Power Electronics, Intelligent Control and Energy Systems (ICPEICES)*, Delhi (2016) 1-5.
- [13] S. M. Ferdous, G. M. Shafiullah, M. A. M. Oninda, M. A. Shoeb, T. Jamal, Close Loop Compensation Technique for High Performance MPPT Using Ripple Correlation Control, *Australasian Universities Power Engineering Conference (AUPEC)*, Melbourne, VIC (2017) 1-6.
- [14] M. B. Shadmand, R. S. Balog, H. Abu-Rub, Model Predictive Control of PV Sources in a Smart DC Distribution System: Maximum Power Point Tracking and Droop Control, *IEEE Transactions on Energy Conversion* 29(4) (2014) 913-921.
- [15] E. Serban, H. Serban, A Control Strategy for A Distributed Power Generation Microgrid Application with Voltage- and Current-Controlled Source Converter, *IEEE Transactions on Power Electronics* 25(12) 2010 2981-2992.
- [16] Mohamed A. Farahat, Mohamed A. Enany, Ahmed Nasr, Assessment of Maximum Power Point Tracking Techniques for Photovoltaic System Applications, *Journal of Renewable and Sustainable Energy* 7(4) (2015) 1-7.
- [17] J. H. R. Enslin, D. B. Snyman, Simplified Feed-Forward Control of the Maximum Power Point in PV Installations, *Proceedings of the 1992 International Conference on Industrial Electronics, Control, Instrumentation, and Automation*, San Diego, CA 1 (1992) 548-553.
- [18] Sera D., Kerekes T., Teodorescu R., Blaabjerg F., Improved MPPT Algorithms for Rapidly Changing Environmental Conditions, *Power Electronics and Motion Control Conference* (2006) 1614-1619.
- [19] Busa V., Narsingoju K. K., Kumar G. V., Simulation Analysis of Maximum Power Control of Photovoltaic Power System, *International Journal on Advanced Electrical and Electronics Engineering (IJAEED)* 1(1) (2012) 9-14.



- [20] Jusoh A., Sutikno T., Guan T. K., Mekhilef S., A Review on Favourable Maximum Power Point Tracking Systems in Solar Energy Application, *Telkomnika* 12(1) (2014) 6–22.
- [21] Kamarzaman N., Tan C. W., A Comprehensive Review of Maximum Power Point Tracking Algorithms for Photovoltaic Systems, *Renewable and Sustainable Energy Reviews* 37 (2014) 585–598.
- [22] ESRAM T., Chapman P., Comparison of Photovoltaic Array Maximum Power Point Tracking Techniques, *IEEE Transactions on Energy Conversion*, 22(2) (2007) 439–449.
- [23] Yadav A., Thirumaliah S., Haritha, G., Comparison of MPPT Algorithms for DC–DC Converters Based PV Systems, *International Journal of Advanced Research in Electrical, Electronics and Instrumentation Engineering*, 1 (2012) 18–23.
- [24] Rashid M. H., *Power Electronic Handbook*, 4th ed., Butterworth-Heinemann, USA, 2017.
- [25] Zainudin H., Mekhilef S., Comparison Study of Maximum Power Point Tracker Techniques for PV Systems, *International Middle East Power Systems Conference*, Egypt, Cairo University (2010) 750–755.
- [26] Kumari J., Babu Ch., Comparison of Maximum Power Point Tracking Algorithms for Photovoltaic System, *International Journal of Advances in Engineering and Technology* 1 (2011) 133–148.
- [27] Lee J., *Advanced Electrical and Electronic Engineering*, 1st ed., Springer, Berlin Heidelberg, 2011.
- [28] Ali A., Saied M., Mostafa M., Moneim T. (2012). A Survey of Maximum PPT Techniques of PV Systems, 2012 IEEE Energytech, Cleveland, OH (2012) 1–17.
- [29] Rezaei A., Gholamian S. A., Optimization of New Fuzzy Logic Controller by Genetic Algorithm for Maximum Power Point Tracking in Photovoltaic System, *Journal of Science and Technology* 9(1) (2013) 9–16.
- [30] Takun P., Kaitwanidvilai S., Jettanasen C., Maximum Power Point Tracking Using Fuzzy Logic Control for Photovoltaic Systems, *International Multi Conference of Engineers and Computer Scientists*, Hong Kong 2 (2011).
- [31] Rahmani R., Seyedmahmoudian M., Mekhilef S., Yusof, R., Implementation of Fuzzy Logic Maximum Power Point Tracking Controller for Photovoltaic System, *American Journal of Applied Sciences* 10 (2013) 209–218.
- [32] Coelho R., Concer F., Martins D., A MPPT Approach Based on Temperature Measurements Applied in PV Systems, *IEEE/IAS International Conference on Industry Applications* (2010) 1–6.
- [33] Abdulmajeed Q. M., Kazem H. A., Mazin H., Abd Malek M. F., Maizana D., Alwaeli A. H. A., Albadi M. H., Sopian K., Said Al Busaidi A., Photovoltaic Maximum Tracking

- Power Point System: Review and Research Challenges, *International Journal of Advanced Trends in Computer Science and Engineering (IJATCSE)* 2(5) (2013) 16–21.
- [34] E. Koutroulis, F. Blaabjerg, Overview of Maximum Power Point Tracking Techniques for Photovoltaic Energy Production Systems, *Electric Power Components and Systems* 43(12) (2015) 1329-1351.
- [35] Morales D. S., *Maximum Power Point Tracking Algorithms for Photovoltaic Applications*, A thesis Presented to the Faculty of Electronics, Communications and Automation, Aalto University, Finland, 2010.
- [36] Tse K. K., Ho M. T., Chung H. S.-H., Hui S. Y., A Novel Maximum Power Point Tracker for PV Panels Using Switching Frequency Modulation, *IEEE Transactions on Power Electronics*, 17(6) (2002) 980–989.
- [37] Chen C. J., *Physics of Solar Energy*, 1st ed., Wiley, New Jersey, 2011.
- [38] Reported issued by National Instruments, *Maximum Power Point Tracking*, <http://www.ni.com/white-paper/8106/en>, 2009.
- [39] Faranda R., Leva S., Energy Comparison of MPPT Techniques for PV Systems, *Wseas Transaction on Power Systems* 3 (2008) 446–455.
- [40] Walker S., Sooriyaarachchi N., Liyanage N., Abeynayake P., Abeyratne S., Comparative Analysis of Speed of Convergence of MPPT Techniques, 6th International Conference on Industrial and Information Systems, Sri Lanka (2011) 522-526.
- [41] Ji Y. H., Jung D. Y., Won C. Y., Lee B. K., Kim J. W., Maximum Power Point Tracking Method for PV Array Under Partially Shaded Condition, *Energy Conversion Congress and Exposition* (2009) 307–312.
- [42] Khatib T. T. N., Mohamed A., Amim N., An Improved Indirect Maximum Power Point Tracking Method for Standalone Photovoltaic Systems, *Proceedings of the 9th WSEAS International Conference on Applications of Electrical Engineering*, Selangor, Malaysia (2010) 56–62.
- [43] Jain S., Agarwa V., Comparison of the Performance of Maximum Power Point Tracking Schemes Applied to Single-Stage Grid-Connected Photovoltaic Systems, *The Institution of Engineering and Technology Power Appl.* 1(5) (2007) 753–762.
- [44] Sera D., Kerekes T., Teodorescu R., Blaabjerg F., Improved MPPT Algorithms for Rapidly Changing Environmental Conditions, *Power Electronics and Motion Control Conference* (2006) 1614–1619.
- [45] Yadav A., Thirumaliah S., Haritha G., Comparison of MPPT Algorithms for DC–DC Converters Based PV Systems, *International Journal of Advanced Research in Electrical, Electronics and Instrumentation Engineering* 1 (2012) 18–23.
- [46] Ghazanfari J., Farsangi M., Maximum Power Point Tracking Using Sliding Mode Control for Photovoltaic Array, *Iranian Journal of Electrical &*

- Electronic Engineering 9(3) (2013) 189–196.
- [47] Brito M., Galotto L., Sampaio L., Melo G., Canesin C., Evaluation of the Main MPPT Techniques for Photovoltaic Applications, *IEEE Transactions on Industrial Electronics* 60(3) (2013) 1156–1167.
- [48] Lyden S., Haque M. E., Maximum Power Point Tracking Techniques for Photovoltaic Systems: A Comprehensive Review and Comparative Analysis, 52 (2015) 1504–1518.
- [49] Jiang J., Huang T., Hsiao Y., Chen Ch., Maximum Power Tracking for Photovoltaic Power Systems, *Tamkang Journal of Science and Engineering* 8(2) (2005) 147–153.
- [50] Rekioua D., Matagne E., Optimization of Photovoltaic Power Systems Modelization, Simulation and Control, 1st ed., Springer, London, 2012.
- [51] Hohm D. P., Ropp M. E., Comparative Study of Maximum Power Point Tracking Algorithms, *Progress in Photovoltaic: Research and Application* 11 (2003) 47–62.
- [52] Mastromauro R., Liserre M., Aquila A., Control Issues in Single-Stage Photovoltaic Systems: MPPT, Current and Voltage Control, *IEEE Transactions on Industrial Informatics* 8(2) (2012) 241–254.
- [53] Kumar Ch., Dinesh T., Babu S., Design and Modelling of PV System and Different MPPT Algorithms, *International Journal of Engineering Trends and Technology (IJETT)* 4 (2013) 4104–4112.
- [54] Liu C., Wu B., Cheung R., Advanced Algorithm for MPPT Control of Photovoltaic System, *Canadian Solar Buildings Conference*, Montreal, (2004).
- [55] Yafaoui A., Wu B., Cheung R., Implementation of Maximum Power Point Tracking Algorithm For Residential Photovoltaic Systems, 2nd *Canadian Solar Buildings Conference*, Calgary, (2007).
- [56] Hu J., Zhang J., Wu H., Novel MPPT Control Algorithm Based on Numerical Calculation for PV Generation Systems, *Power Electronics and Motion Control Conference*, China, Baoding (2009) 2103–2107.
- [57] Vladimir V. R., Scarpa S., Buso G., Spiazzi., Low-Complexity MPPT Technique Exploiting the PV Module MPP Locus Characterization, *IEEE Transactions on Industrial Electronics* 56(5) (2009) 1531-1538.
- [58] Go S., Ahn S., Choi J., Jung W., Yun Yun S., Song II., Simulation and Analysis of Existing MPPT Control Methods in a PV Generation System, *Journal of International Council on Electrical Engineering* 1(4) (2011) 446-451.
- [59] Yang Y., Yan Z., A MPPT Method Using Piecewise Linear Approximation and Temperature Compensation, *Journal of Computational Information Systems* 9(21) (2013) 8639–8647.
- [60] Mandour R., Elamvazuthi I. Optimization of Maximum Power Point Tracking (MPPT) of

- Photovoltaic System Using Artificial Intelligence (AI) Algorithms, *Journal of Emerging Trends in Computing and Information Sciences* 4(8) (2013) 662–669.
- [61] Zhou L., Chen Y., Liu Q., Wu J., Maximum Power Point Tracking (MPPT) Control of A Photovoltaic System Based on Dual Carrier Chaotic Search, *Journal of Control Theory and Applications* 10(2) (2012) 244–250.
- [62] Rahman Md, Poddar S., Mamun M., Mahmud S., Yeasin Md., Efficiency Comparison Between Different Algorithms for Maximum Power Point Tracker of A Solar System, *International Journal of Scientific Research and Management (IJSRM)* 1 (2013) 157–167.
- [63] Abdalla I., Zhang L., Corda J., Voltage-Hold Perturbation & Observation Maximum Power Point Tracking Algorithm (VH-P&O MPPT) for Improved Tracking over the Transient Atmospheric Changes, *Power Electronics and Applications of the 2011-14th European Conference* (2011) 1–10.
- [64] Amrouche B., Belhamel M., Guessoum A., Artificial Intelligence Based P&O MPPT Method for Photovoltaic Systems, *Revue des Energies Renouvelables (ICRES)* 7 (2007) 11–16.
- [65] Qiang F., Nan T., A Strategy Research on MPPT Technique in Photovoltaic Power Generation System, *Telkomnika*, 11(12) (2013) 7627–7633.
- [66] Lee J. S., Lee K. B., Variable DC-Link Voltage Algorithm with A Wide Range of Maximum Power Point Tracking for A Two-String PV System, *Energies* 6 (2013) 58–78.
- [67] Reisi A., Moradi M., Jamasb S. Classification and Comparison of Maximum Power Point Tracking Techniques for Photovoltaic System: A Review, *Renewable and Sustainable Energy Reviews* 19 (2013) 433–443.
- [68] Xiao W., Dunford W., Palmer P., Capel A., Application of Centered Differentiation and Steepest Descent to Maximum Power Point Tracking, *IEEE Transactions on Industrial Electronics* 54(5) (2007) 2539–2549.
- [69] Rodriguez C., Amaratunga G., Analytic Solution to the Photovoltaic Maximum Power Point Problem, *IEEE Transactions on Circuits and System* 54(9) (2007) 2054–2060.
- [70] Azab M., A New Maximum Power Point Tracking for Photovoltaic Systems, *World Academy of Science, Engineering and Technology* 44 (2008) 571–574.
- [71] Zazo H., Leyva R., Castillo E., Analysis of Newton-Like Extremum Seeking Control in Photovoltaic Panels, *International Conference on Renewable Energies and Power Quality (ICREPQ'12)*, Santiago de Compostela, Spain 1(10) (2012) 561–566.
- [72] Leyva R., Olalla Martinez C., Zazo H., Cabal, C., Cid-Pastor A., Queinnec I., Alonso C., MPPT Based on Sinusoidal Extremum-Seeking Control in PV

- Generation, *International Journal of Photoenergy* (2012) 1–7.
- [73] Lapeña O., Penella M., Gasulla M.m A New MPPT Method for Low-Power Solar Energy Harvesting, *IEEE Transactions on Industrial Electronics* 57(9) (2010) 3129–3138.
- [74] Kulaksiz A., Akkaya R., Training Data Optimization for ANNs Using Genetic Algorithms to Enhance MPPT Efficiency of A Stand-Alone PV Systemm *Turkish Journal of Electrical Engineering and Computer Sciences* 20(2) (2012) 241–254.